

K A U R I



1920 **R**<sup>®</sup>  
MADE IN ITALY  
DESIGN ECO 

K A U R I

1920 **R**<sup>®</sup>  
MADE IN ITALY

1920 **R**<sup>®</sup> 2020  
MADE IN ITALY  
100<sup>th</sup>  
anniversary

“KAURI,  
DAL CUORE DELLA TERRA  
UN LEGNO MILLENARIO DI  
50.000 ANNI”

“KAURI  
*FROM THE HEART OF  
THE EARTH AN ANCIENT  
WOOD AGED 50.000  
YEARS*”

“KAURI,  
*EIN 50.000 JAHRE ALTES  
HOLZ AUS DEM HERZEN  
DER WELT*”

INDICE · INDEX · INHALT



FILOSOFIA  
*PHILOSOPHY*  
*PHILOSOPHIE* 4

148  
CERTIFICATO DI  
AUTENTICITA'  
*CERTIFICATE OF  
AUTHENTICITY*  
*ECHTHEITSZERTIFIKAT*



22  
TAVOLI  
*TABLES*  
*TISCHE*



ESSENZE E FINITURE  
*WOOD AND FINISHES* 152  
*HÖLZER UND  
AUSFÜHRUNGEN*



TAVOLINI  
*SMALL TABLES* 116  
*COUCHTISCHE*

154  
SET DI  
MANUTENZIONE/  
TARGHETTA  
*MAINTENANCE SET /  
IDENTIFICATION PLATE*  
*PFLEGESET / LOGO  
PLAKETTE*



136  
ART & SPECIALS



NATURAL LIVING/  
DESIGN ECO 156

## RIVA 1920

Riva 1920 racconta di un dialogo ininterrotto tra estetica ed etica. La storia di un'azienda con solide radici e una grande artigianalità, che da quasi 100 anni coniuga innovazione e design nel rispetto dell'ambiente e della migliore tradizione del Made in Italy. Collaborando con i principali protagonisti di architettura e arte, si distingue per la produzione di arredi di eccellente qualità in cui il legno è il protagonista indiscusso, dando vita a qualcosa di speciale, unico e senza tempo.

*Riva 1920 integrates seamlessly aesthetics and ethics. The company with its solid historical roots and great craftsmanship, for almost 100 years combined innovation and design, while respecting the environment and the best Made-in-Italy tradition. Partnering with the main architecture and art exponents, Riva 1920 stands out in the production of excellent quality furniture where wood is the undisputed focus and gives life to unique and timeless objects.*

*Riva 1920 ist Inbegriff eines ständigen Dialogs zwischen Ästhetik und Ethik. Ein Unternehmen mit soliden Wurzeln und einer langjährigen Handwerkstradition, das seit fast 100 Jahren Innovation und Design mit Umweltschutz und Qualität „Made in Italy“ kombiniert. Dank der Zusammenarbeit mit bedeutenden Architekten und Designer produziert es hochwertige Einrichtungen, die sich durch ihre Einzigartigkeit und Zeitlosigkeit auszeichnen und bei denen das Holz im Mittelpunkt steht.*

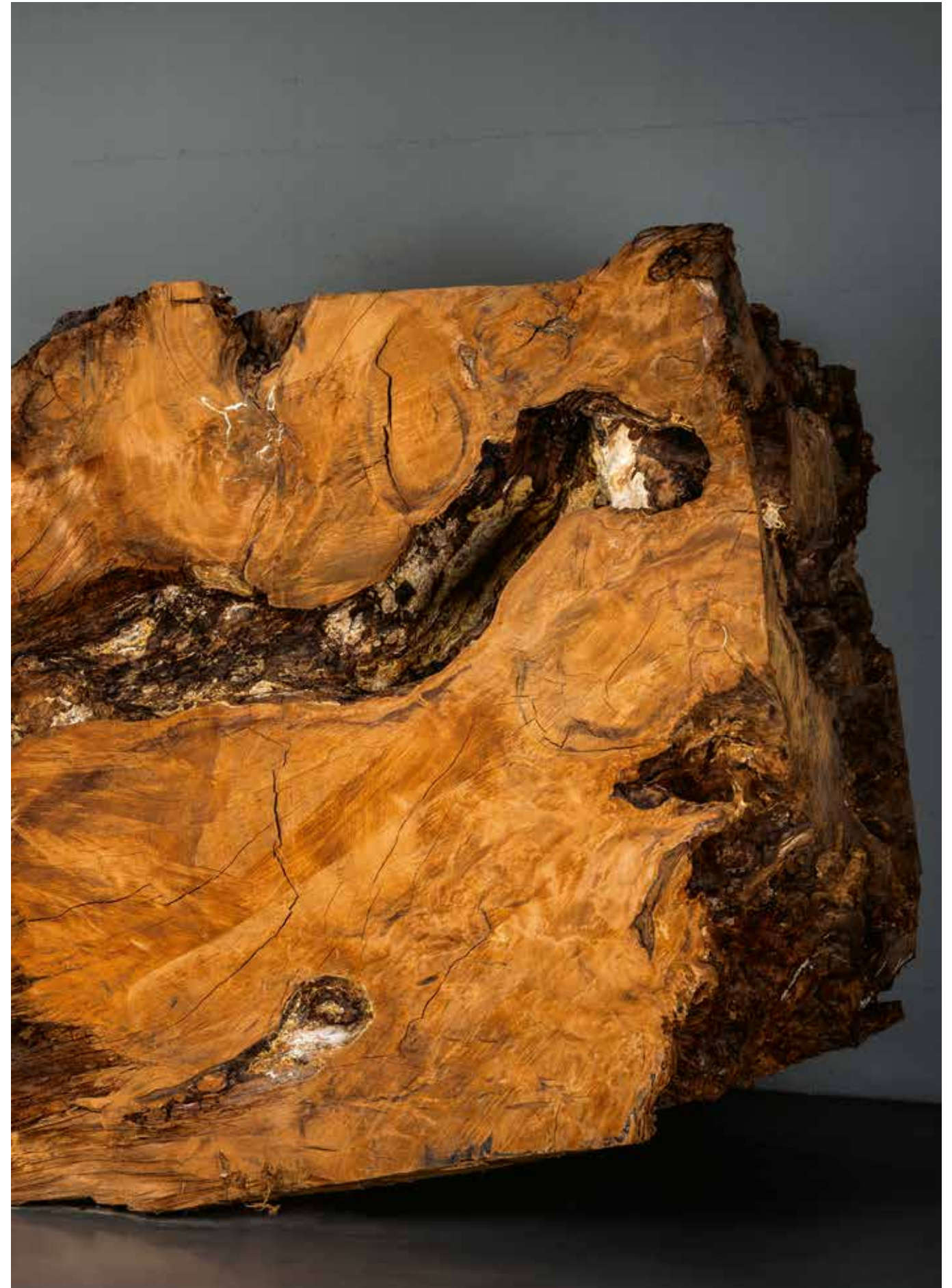



## KAURI · SIGNORE DELLA FORESTA

Il Kauri (*Agathis Australis*) è un tipo di conifera che vive solo nei climi sub-tropicali della Nuova Zelanda, i primi esemplari fecero la loro comparsa nel periodo Giurassico circa 190/135 milioni di anni fa. Sono gli alberi più grandi del mondo per cubatura del tronco, superano infatti i 70 metri di altezza e hanno un diametro che può raggiungere i 9 metri, purtroppo molte di queste foreste sono state tagliate all'arrivo dei colonizzatori inglesi per ricavarne legname e fare spazio alla pastorizia. Oggi questi alberi sono tutelati dal governo Neo-Zelandese ed il taglio è severamente vietato.

Il Kauri più grande ancora vivente è "Tane Mahuta" ovvero "Signore Della Foresta" in lingua Maori.

## KAURI · LORD OF THE FOREST

*The Kauri (Agathis Australis) is a kind of conifer living only in the sub-tropical climates of New Zealand. The first of them appeared during the Jurassic period about 190/135 million years ago. They are the world's biggest trees in terms of trunk volume and have a height of up to 70 meters and a diameter of up to 9. Unfortunately many of their forests were felled by English colonists on arrival to obtain timber or land for farming. All the remaining trees are now under governmental and legal protection and their cut is strictly forbidden.*

*The biggest surviving Kauri is the 'Tane Mahuta' or 'Lord Of The Forest' in the Maori language.*

## KAURI · HERR DER WALD

*Kauri (Agathis Australis) ist ein Nadelbaum, der nur im subtropischen Klima Neuseelands lebt. Die ersten Exemplare stammen aus der Jurazeit, vor etwa 190/135 Millionen Jahren. Bezogen auf die Kubikmeter des Stammes, handelt es sich bei den Kauris um die größten Bäume der Welt. In der Tat sind sie mehr als 70 Meter hoch und können einen Durchmesser von 9 Metern erreichen. Leider wurde eine Vielzahl dieser Wälder in der Kolonialzeit zur Holzgewinnung und für die Schaffung von Weideflächen gerodet. Die neuseeländische Regierung hat diese Bäume unter Naturschutz gestellt; das Fällen dieser Bäume ist heute strengstens verboten.*

*Der heute noch lebende größte Kauribaum ist der sogenannte „Tane Mahuta“, was in Sprache der Maori „Herr der Wald“ bedeutet.*

## KAURI · LE ORIGINI

Circa 50.000 anni fa, alla fine dell'ultima era glaciale, una serie di cataclismi ancora oggi inspiegabili hanno abbattuto intere foreste di Kauri sommergendole di acqua e di fango.

Scavando nel terreno si incontrano vere e proprie "miniere di legno"; l'eccezionalità sta nel fatto che nonostante la permanenza millenaria sotto il fango questi tronchi risultano perfettamente conservati e presentano le stesse caratteristiche di un legno appena tagliato. Le particolari condizioni di tale fango e la mancanza assoluta di ossigeno hanno permesso agli alberi, rimasti intrappolati nelle paludi per 30/40/50 mila anni, di sfidare i processi chimici di decomposizione e di pietrificazione per arrivare intatte fino ai nostri giorni.

Una volta trovato un giacimento un campione viene prelevato e sottoposto alla datazione con il metodo del Carbonio 14, l'età delle piante varia dai 7.000 ai 50.000 anni.

## KAURI · THE ORIGIN

*About 50.000 years ago, at the end of the last ice age, a series of unexplained cataclysms submerged whole forests of kauris in water and mud. Digging the soil veritable "wood mines" are found; the exceptionality is that, although being buried underground for thousands of years, these logs are perfectly preserved and have the same quality as timber just felled. The specific qualities of the mud and the absolute lack of oxygen exempted these plants, trapped in the swamps for 30/40/50 thousand years, from the chemical processes of decomposition and petrification, letting them remain intact to the present day.*

*Once a new "mine" is found a sample of the logs is collected and then submitted to the carbon-14 dating the age of the logs varies between 7000 and 50.000 years.*

## KAURI · DER URSPRUNG

*Am Ende der letzten Eiszeit, vor etwa 50.000 Jahren, hat eine Serie noch ungeklärter Kataklismen ganze Kauri-Wälder gefällt und mit Wasser und Schlamm bedeckt. Wenn man im Boden gräbt, findet man richtige „Holzminen“; die Einzigartigkeit liegt darin, dass trotz der tausendjährigen Permanenz im Schlamm, die Stämme perfekt erhalten sind und die gleichen Eigenschaften wie frisch geschlagenes Holz aufweisen. Die besonderen Eigenschaften dieses Schlammes und das vollständige fehlen von Sauerstoff haben es diesen für 30/40/50 Tausend Jahre im Moor gefangenen Pflanzen ermöglicht, den chemischen Zersetzungs- und Versteinerungsprozessen entgegenzuwirken und so bis heute intakt zu bleiben.*

*Wenn man neue „Vorkommen“ findet, wird ein Muster des Holzes mit der C14-Datierung untersucht, das Alter des Holzes variiert zwischen 7.000 und 50.000 Jahre.*



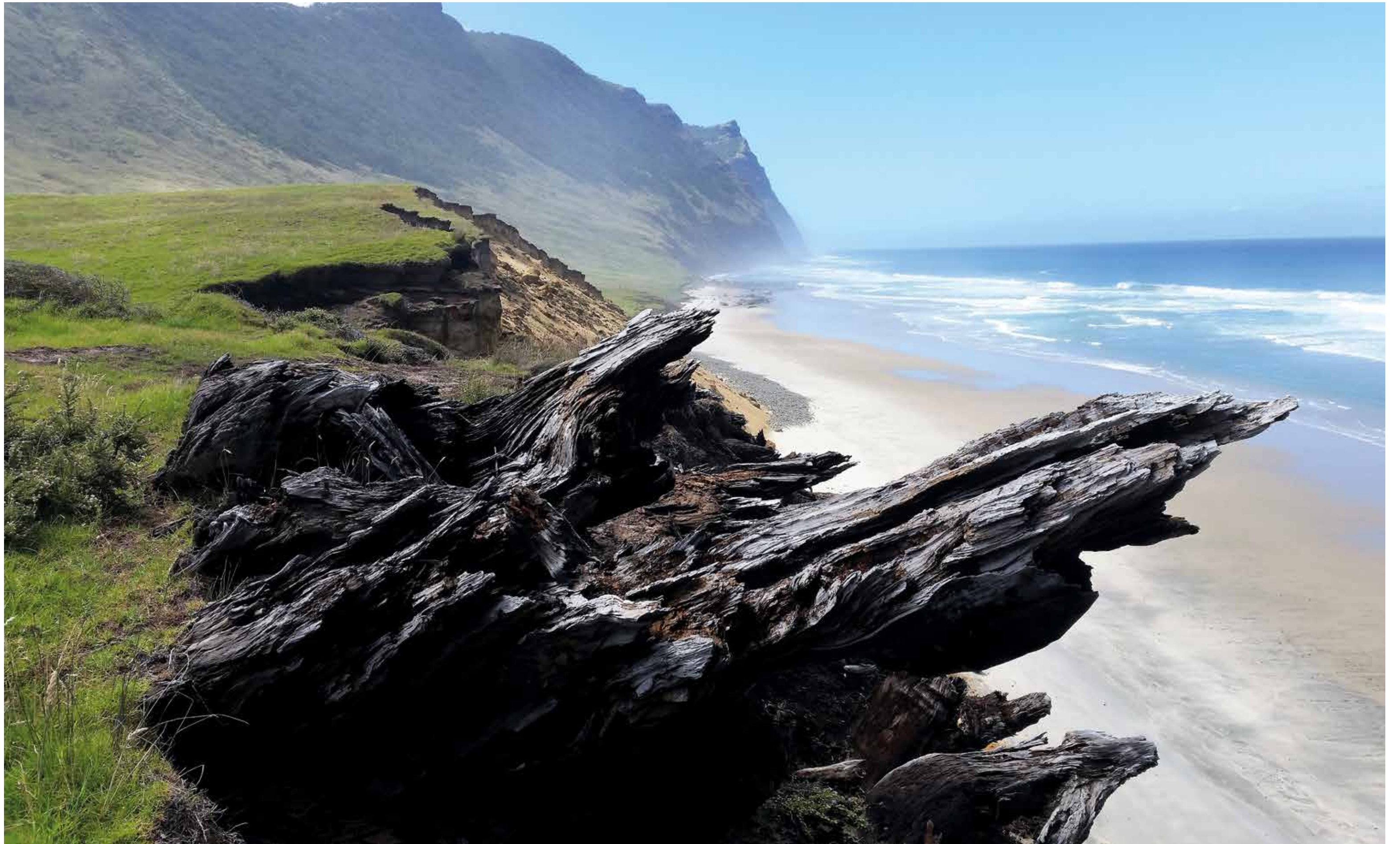

## ESTRAZIONE

Una volta individuato il "giacimento", si procede con l'estrazione mediante l'uso di escavatori e ruspe. Le operazioni di recupero presentano particolari difficoltà considerate le condizioni del terreno fangoso e cedevole in luoghi tutt'altro che accessibili e date le notevoli dimensioni dei tronchi che obbligano all'impiego di mezzi pesanti. I tronchi, che possono avere un peso di 200/300 tonnellate, sono tali da forzare gli operatori al taglio in due o più parti per consentirne il sollevamento e il trasporto.

## EXTRACTION

*Once a new "mine" has been located, the logs can be extracted with excavators and bulldozers. Recovery operations are difficult due to the muddy and infirm terrain in places hardly accessible and to the notable size of trunks, which can be lifted by only heavy equipment. The trunks may weigh up to 200/300 tons, so operators have to cut them into two or more parts before being able to lift them and take them away.*

## GEWINNUNG

*Wenn neue „Vorkommen“ entdeckt sind, werden die Stämme mit Hilfe von Baggern und Raupen gewonnen. Aufgrund der schwer zugänglichen Bereiche, des sumpfigen Bodens und der Größe der Stämme sind diese Ausgrabungsarbeiten besonders schwierig (es kommen schwere Geräte zum Einsatz). Die Stämme können bis zu 200/300 Tonnen wiegen. Die Arbeiter müssen sie daher in zwei oder mehr Teile schneiden, um sie ausgraben und transportieren zu können.*







## LAVORAZIONE

Le porzioni di tronchi vengono sezionate in tavole, si tratta di un'operazione molto delicata che richiede un'attenta e lunga lavorazione al fine di ottenere spessori omogenei, che hanno richiesto la messa a punto di un sistema di taglio tangenziale che riducesse al minimo la movimentazione degli enormi tronchi. Il clima piovoso dell'inverno e la natura semi-paludosa dei terreni, obbliga gli operatori ad effettuare le operazioni di scavo solo nella stagione asciutta e dedicare i mesi invernali alla lavorazione e finitura del materiale.

## PROCESSING

*These portions of the trunks are then cut into boards in a most delicate operation which calls for long and careful processing to obtain a constant thickness, which requires a system of tangential cutting to minimize moving the enormous trunks. The rainy winters and the swampy terrain force operators to do the excavating in only the dry season and to devote the months of winter to working on and finishing the materials.*

## VERARBEITUNG

*Danach wird jedes Teil der Stämme in Platten geschnitten. Hierbei handelt es sich um einen sehr delikaten Arbeitsschritt, der eine sorgfältige und lange Verarbeitung erfordert, damit eine homogene Stärke erreicht werden kann. Dazu wurde ein Fladerschnittsystem entwickelt, bei dem die enormen Stämme nur so wenig wie möglich bewegt werden müssen. Aufgrund des regenreichen Klimas im Winter und der Sumpflandschaft kann das zuständige Unternehmen nur während der Trockenzeit graben, während die Wintermonate zur Verarbeitung des Materials bestimmt sind.*

## DEPOSITO

Riva 1920, alla costante ricerca di pezzi singolari uno di uno, dispone di un magazzino tronchi nel quale sono stoccate tavole in Kauri che hanno dimensioni che arrivano fino ai 12 metri di lunghezza e ai 2.40 metri di larghezza con uno spessore che va dagli 8 cm ai 14 cm.

Si tratta di un vero e proprio atelier del legno, costantemente alimentato da nuove forniture che periodicamente arrivano a destinazione dopo un lungo viaggio via mare.

## WAREHOUSE

*Riva 1920, always searching for unique pieces, has a warehouse where Kauri slabs up to 12 meters in length and 2.40 meters in width and with thickness between 8 and 14 cm are stored. It is a veritable wood house, constantly updated thanks to periodical incoming deliveries after long sea journeys.*

## LAGER

*Riva 1920, immer auf der Suche nach Unikate, verfügt über ein großes Lager wo Kauriplatten bis 12 Meter lang und 2.40 Meter breit mit Stärken zwischen 8 und 14 cm gestapelt sind. Ein echtes „Holzatelier“, das dank regelmäßigen See-Lieferungen mit neuen Platten ständig versorgt wird.*

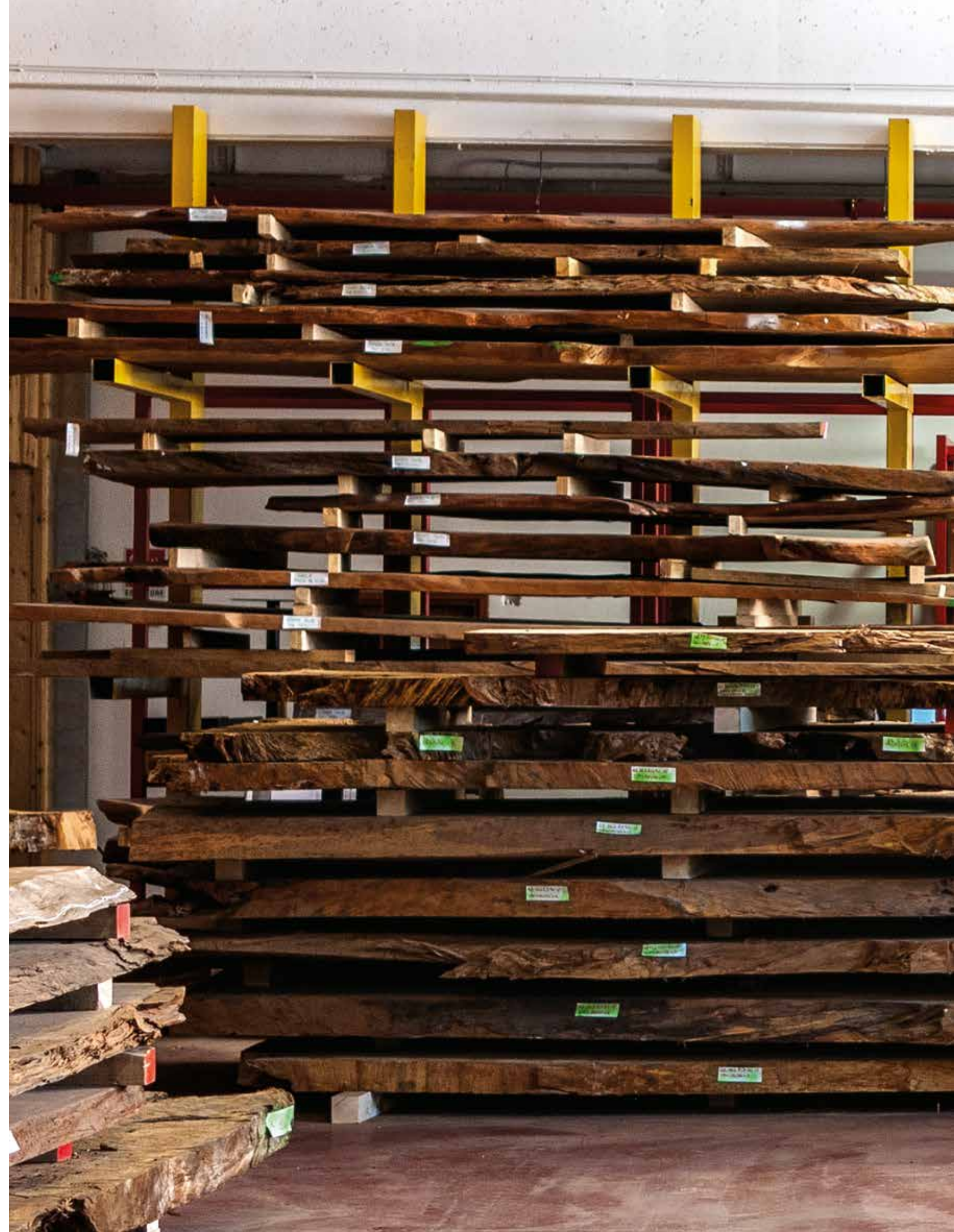

## LEVIGATURA · RESINATURA · OLIATURA

Le tavole grezze hanno la possibilità di essere lavorate con la resina: un processo molto delicato e lento che permette di "imprigionare" il legno all'interno di una cornice trasparente andando a colmarne le anse naturali e ad uniformarne i bordi.

Il tavolo viene poi levigato a mano al fine di rendere la superficie omogenea e liscia al tatto; il passaggio successivo prevede la finitura a base di olii di origine vegetali.

## SANDING · RESIN · OIL

*The raw slabs can be worked with resin, through a very delicate and slow process that permits to capture the wood inside a transparent frame, by filling its natural cavities and levelling out the sides.*

*The table is then sanded by hand to obtain an evenly smooth surface; the final process is the finishing through oil of vegetable origin.*

## SCHLEIFEN · KUNSTHARZ · ÖL

*Die rohen Platten können dank einem feinen und langsamen Prozess mit Kunstharz bearbeitet werden, was die Kanten oder die Vertiefungen ausfüllen kann.*

*Die Platte wird dann per Hand geschliffen, damit die Oberfläche ganz glatt zwischen Holz und Kunstharz ist, und schließlich geölt.*

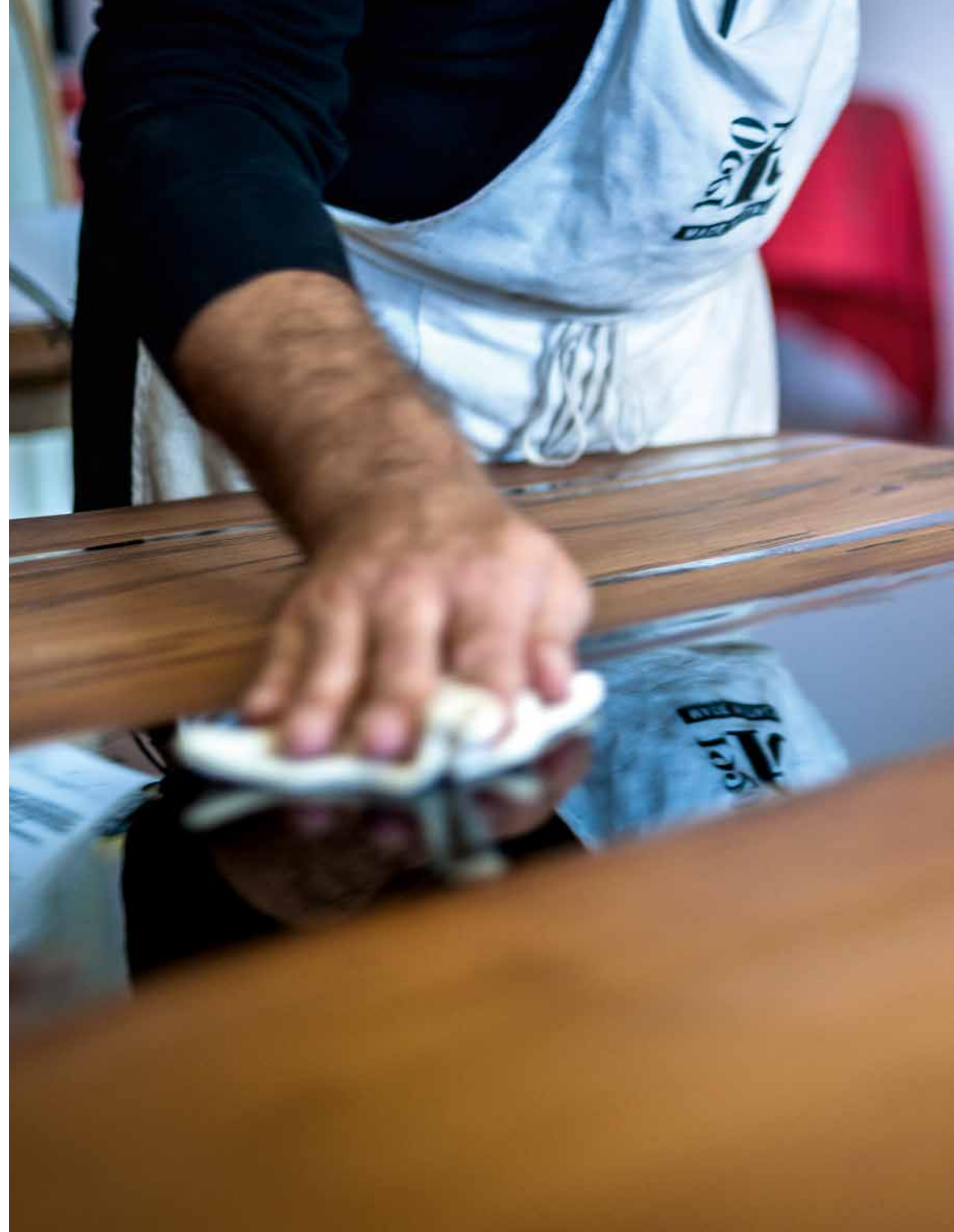



## COLLEZIONE KAURI

Riva 1920 ha saputo interpretare in maniera straordinaria questo meraviglioso materiale che grazie a mani sapienti si trasforma in tavoli che sono delle vere e proprie opere d'arte messe a disposizione dalla natura. Lavorazioni artigianali trasformano semplici assi di legno in pezzi originali e non replicabili, oggetti straordinari che si distinguono e stupiscono per la loro personalità. Il tavolo racconta molto della storia di una casa, rappresenta l'arredo per eccellenza e non ha solo una funzione pratica; attorno al tavolo si vivono alcune delle emozioni più importanti delle nostre esistenze ecco perché il legno un materiale caldo, vivo, vero, autentico e sempre fedele a sé stesso. Un tavolo in legno mette in scena un'esperienza sensoriale che coinvolge più sensi: le sue imperfezioni e i suoi nodi si sentono al tatto, il suo profumo si sprigiona nell'aria, i suoi colori e le sue venature riempiono la vista.

I tavoli in Kauri sono concepiti per un utilizzo indoor, nel caso in cui si volesse utilizzarli per l'outdoor si consiglia vivamente di non acquistare tavole che prevedano la presenza di resina ed in aggiunta si consiglia di effettuare la manutenzione ordinaria su base annuale. Si tratta di prodotti in legno completamente naturali e rifiniti a mano, eventuali movimenti, crepe e mutamenti nelle condizioni del legno sono caratteristica imprescindibile di questi arredi e sono da imputare al naturale assestamento e alle diverse condizioni ambientali.

## KAURI COLLECTION

*Riva 1920 was able to perfectly interpret this amazing material, which thanks to the company expertise is then transformed into tables that are veritable art pieces made available by the nature. The company know-how and the artisan work are able to make original and unique pieces from simple raw slabs, extraordinary products that stand out and impress thanks to their features. The table is an important piece of the house, it is an essential piece of furniture and its use isn't only practical; around the table we live some of the most important emotions of our life, that's why we use the wood, a warm, alive, true and authentic material. A wooden table represents a sensory experience involving several senses: its imperfections and knots the sense of touch, its scent gives off in the air, its colours and grain please the sight.*

*Kauri tables are conceived for indoor use. For outdoor use it is strongly recommended to choose slabs without addition of resin; furthermore, the ordinary maintenance is to be done every year. The products are made from completely natural wood, hand-finished without the addition of any treatment. Movements, cracks and changes in the appearance of the wood are intrinsic characteristics of these items and result from the natural settlement and diverse environmental conditions.*

## KOLLEKTION KAURI

*Riva 1920 ist in der Lage, die Merkmale von diesem wunderschönen hochwertigen Material perfekt hervorzuheben und echte Kunstwerke herzustellen. Dank dem Know-how und der handwerklichen Bearbeitung können die rohen Platten zu wunderbaren Produkten werden, die echte Unikate sind. Der Tisch ist ein sehr bedeutendes Stück der Einrichtung eines Hauses und hat nicht nur einen praktischen Verwendungszweck, sondern um ihn herum lebt man die wichtigsten Gefühle. Daher wird das Holz benutzt, ein warmes, echtes und lebendes Material. Ein Tisch aus Holz ist eine Sinneserfahrung: die Äste betreffen den Tastsinn, der Duft strömt in die Luft aus, die Farbe und die Maserung erfreuen das Auge.*

*Kauritische sind für den Innenbereich gedacht. Für den Außenbereich ist es empfohlen, Platten ohne Kunstharz zu wählen; außerdem soll die Oberfläche jedes Jahr mit dem mitgelieferten Pflegeset behandelt werden. Es handelt sich um vollkommen natürliche Produkte aus Holz, die ohne weitere zusätzliche Behandlung von Hand gefertigt werden. Eventuelle Bewegungen, Risse und Veränderungen des Holzes sind eine wesentliche Eigenschaft dieser Möbelstücke und entstehen durch natürliche Setzungen im Holz und durch die verschiedenen Umweltbedingungen.*

TAVOLI · TABLES · TISCHE



KAURI AUCKLAND 24-41



KAURI BEAM 42-47



KAURI BEDROCK 48-57



KAURI BREE E ONDA 58-61



KAURI CIAK 62-65



KAURI CUBE 66-75



KAURI EARTH 76-81



KAURI EARTH SQUARE 82-87



KAURI NEWTON 88-103



KAURI PIANO ANTICO 104-107



KAURI RIFLESSI MILLENARI 108-115

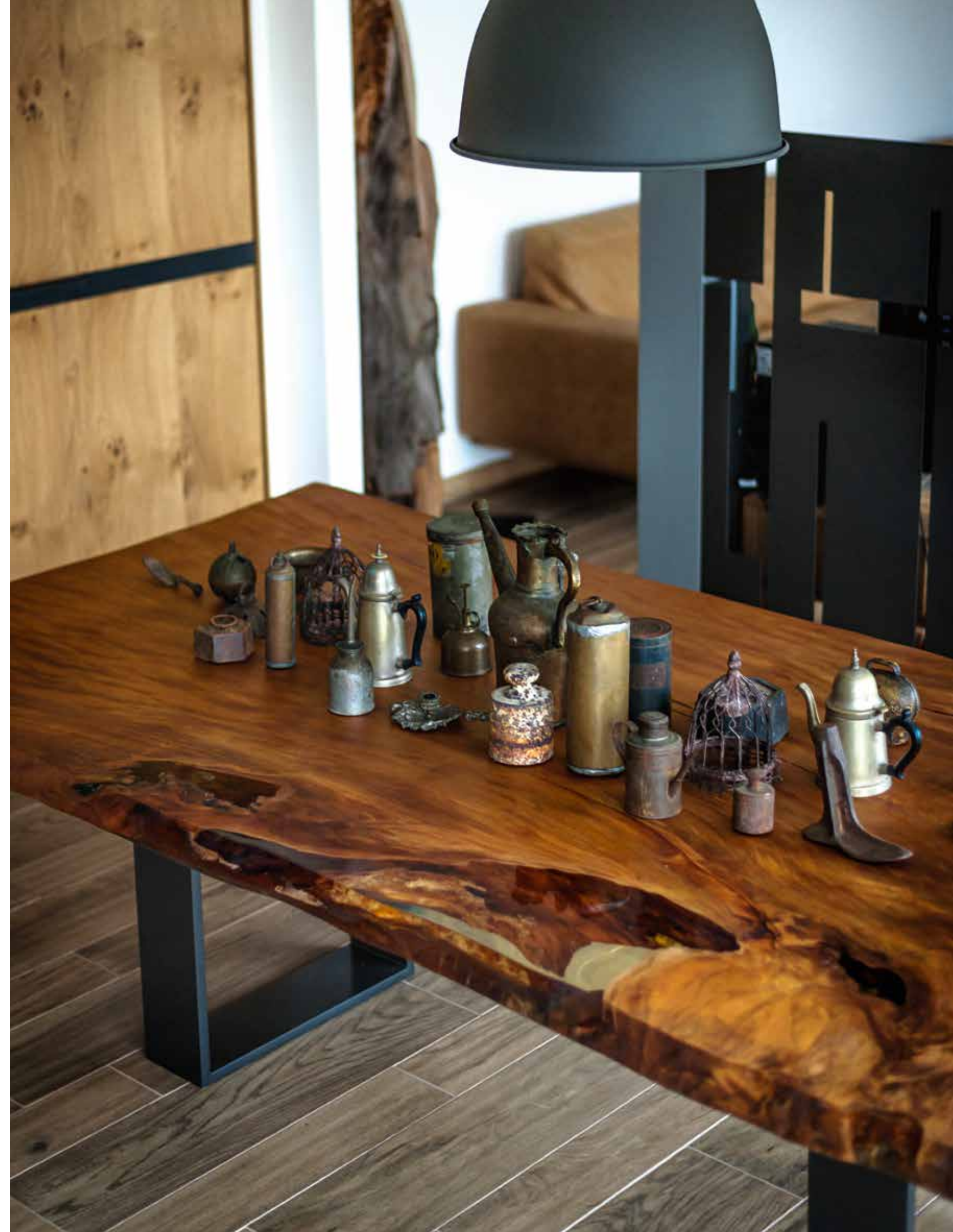



## KAURI AUCKLAND

C.R.&S. RIVA1920



CM: L. 220/600 · P. 100/140 · H. 75

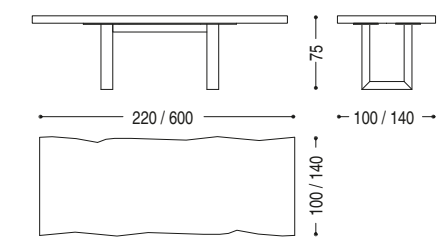

Tavolo realizzato con top in massello di Kauri, abbinato ad una base in ferro con sezione squadrata e saldature a vista.

*Table made with top in solid Kauri, combined with an iron base with squared section and visible welding.*

*Tisch bestehend aus einer Platte aus Kauriholz und einem Natureisengestell mit sichtbaren Schweißnähten.*

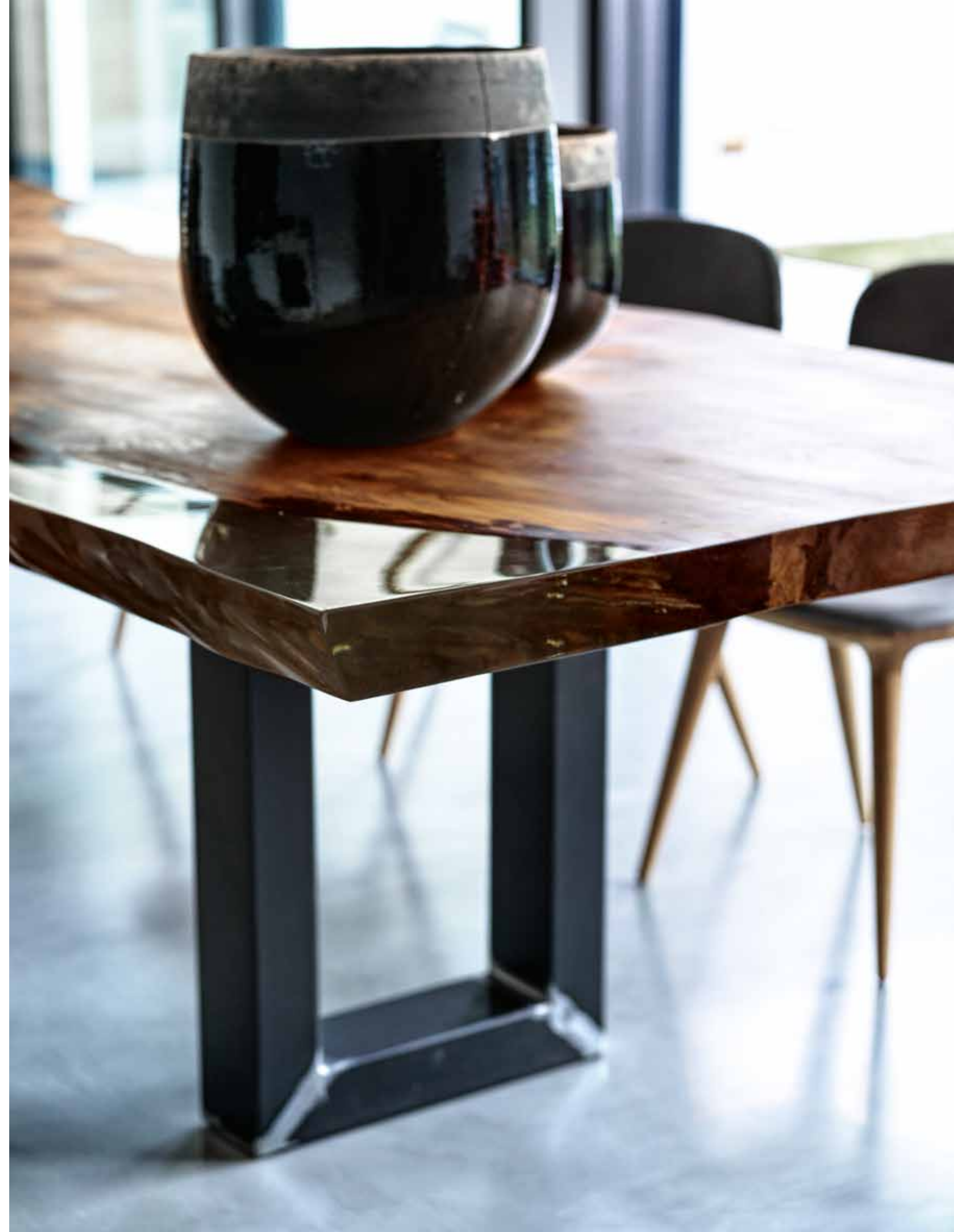





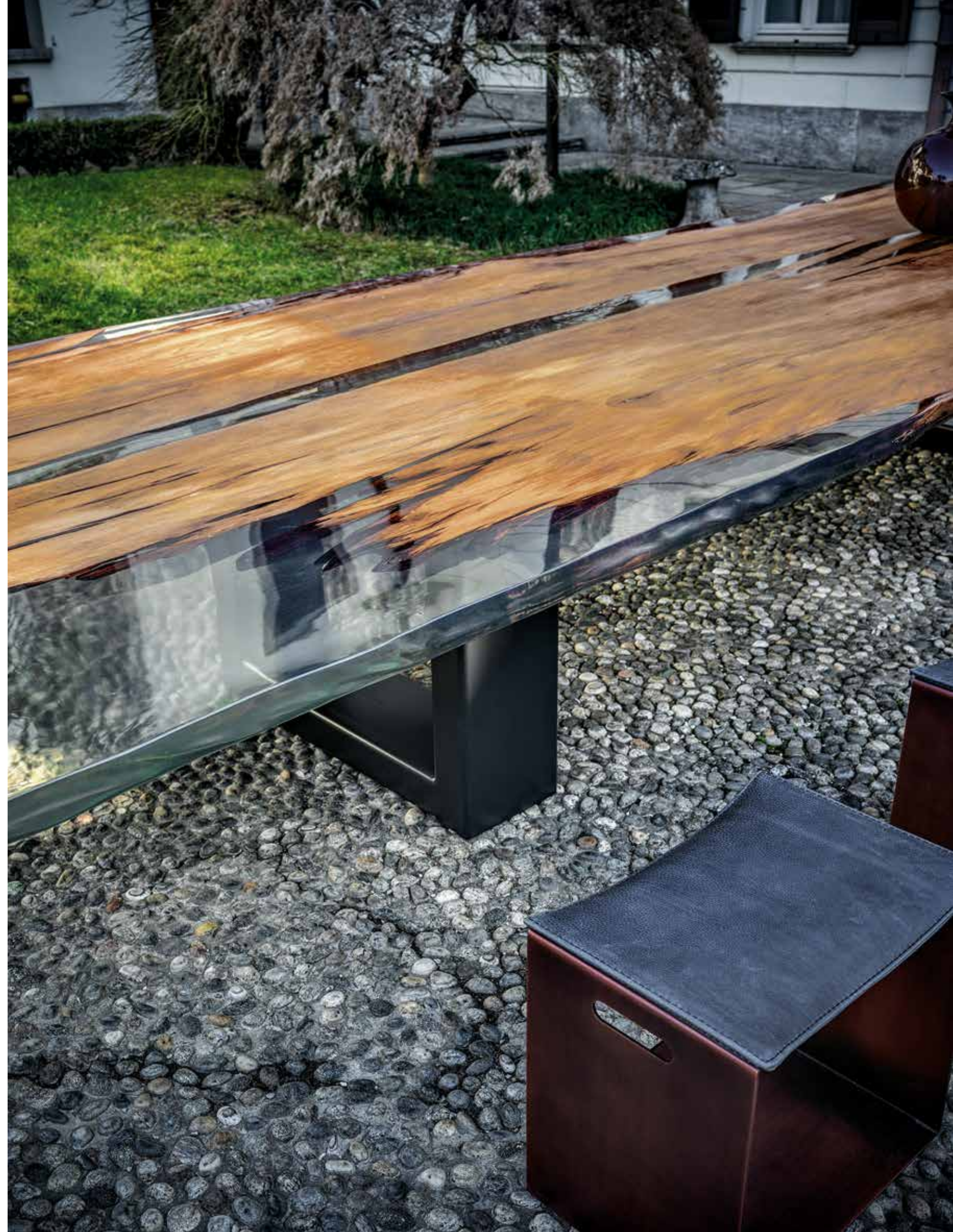



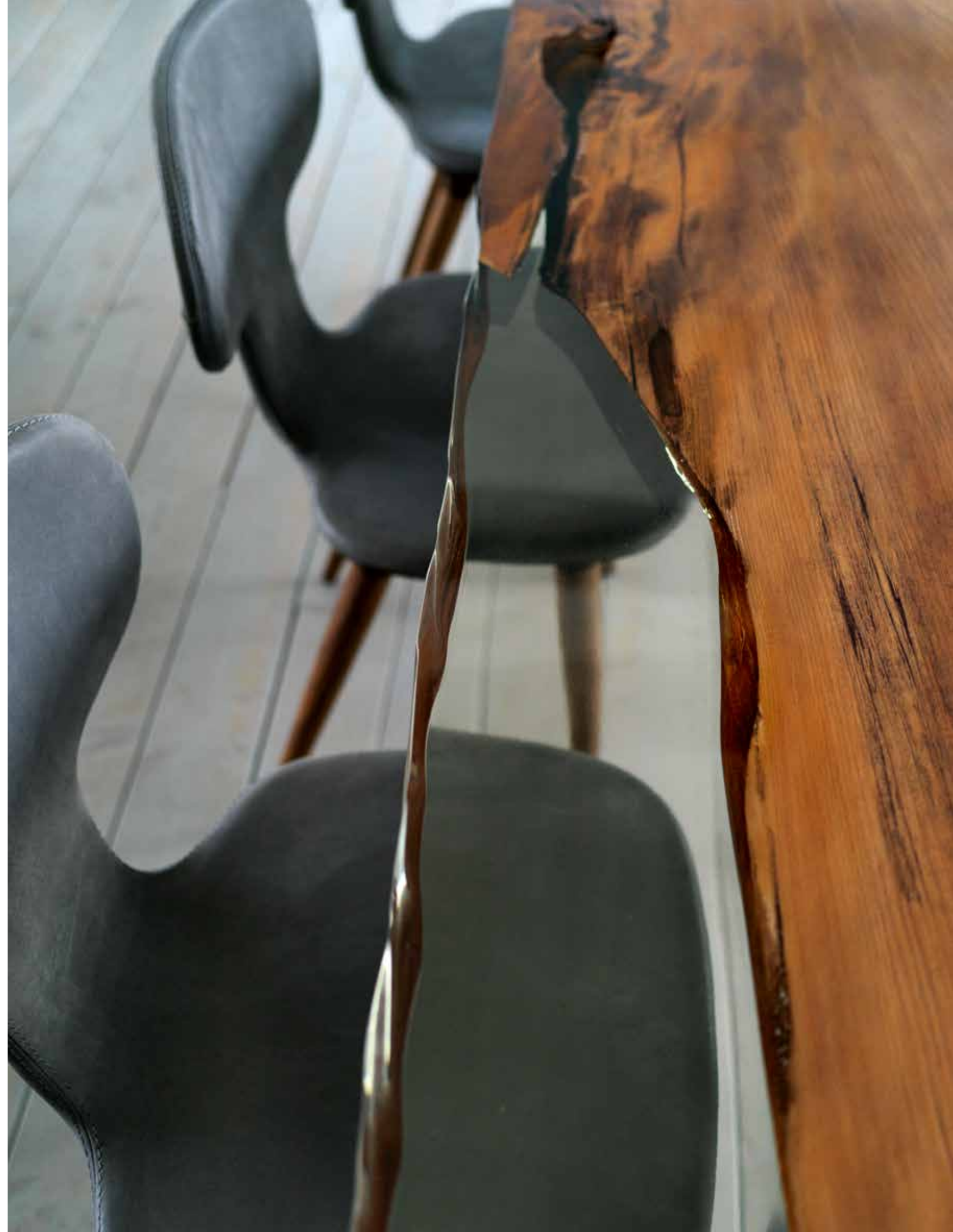







BARBRA

# KAURI BEAM

C.R.&S. RIVA1920



CM: L. 220/600 - P. 100/140 - H. 75

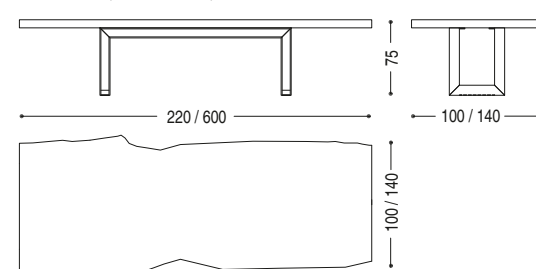

Tavolo realizzato con top in massello di Kauri e base geometrica in ferro con saldature a vista, che si ispira alla putrella (travetto di profilato metallico sagomato a doppio T).

*Table made with top in solid Kauri, combined with a geometric iron base with visible weld joints, inspired to a beam (double T-shaped metal structural element).*

*Tischplatte bestehend aus Kauriholz. Das Untergestell aus Natureisen mit sichtbaren Schweißnähten gibt die Form eines Doppel-T Stahlträgers wieder.*



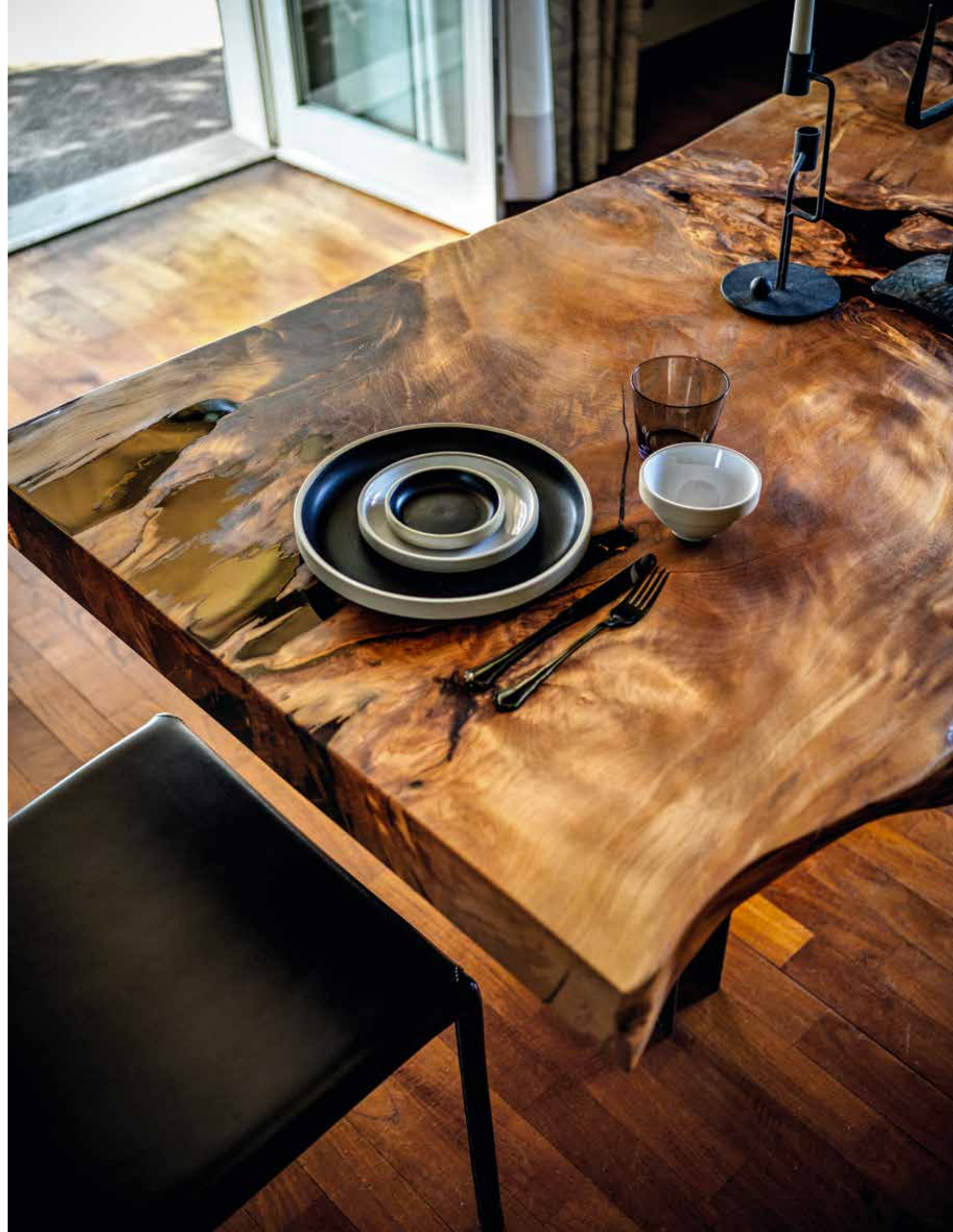





## KAURI BEDROCK

TERRY DWAN

Tavolo realizzato con top in massello di Kauri, abbinato ad una base in lamiera di ferro caratterizzata da linee geometriche.

*Table made with top in solid Kauri and base in iron plate characterised by geometric lines.*

*Tisch bestehend aus einer Platte aus Kauriholz und einem Gestell aus Natureisen mit geometrischem Design.*

CM: L. 220/400 · P. 90/140 · H. 76

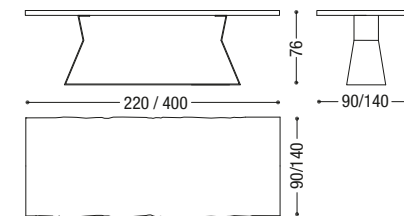

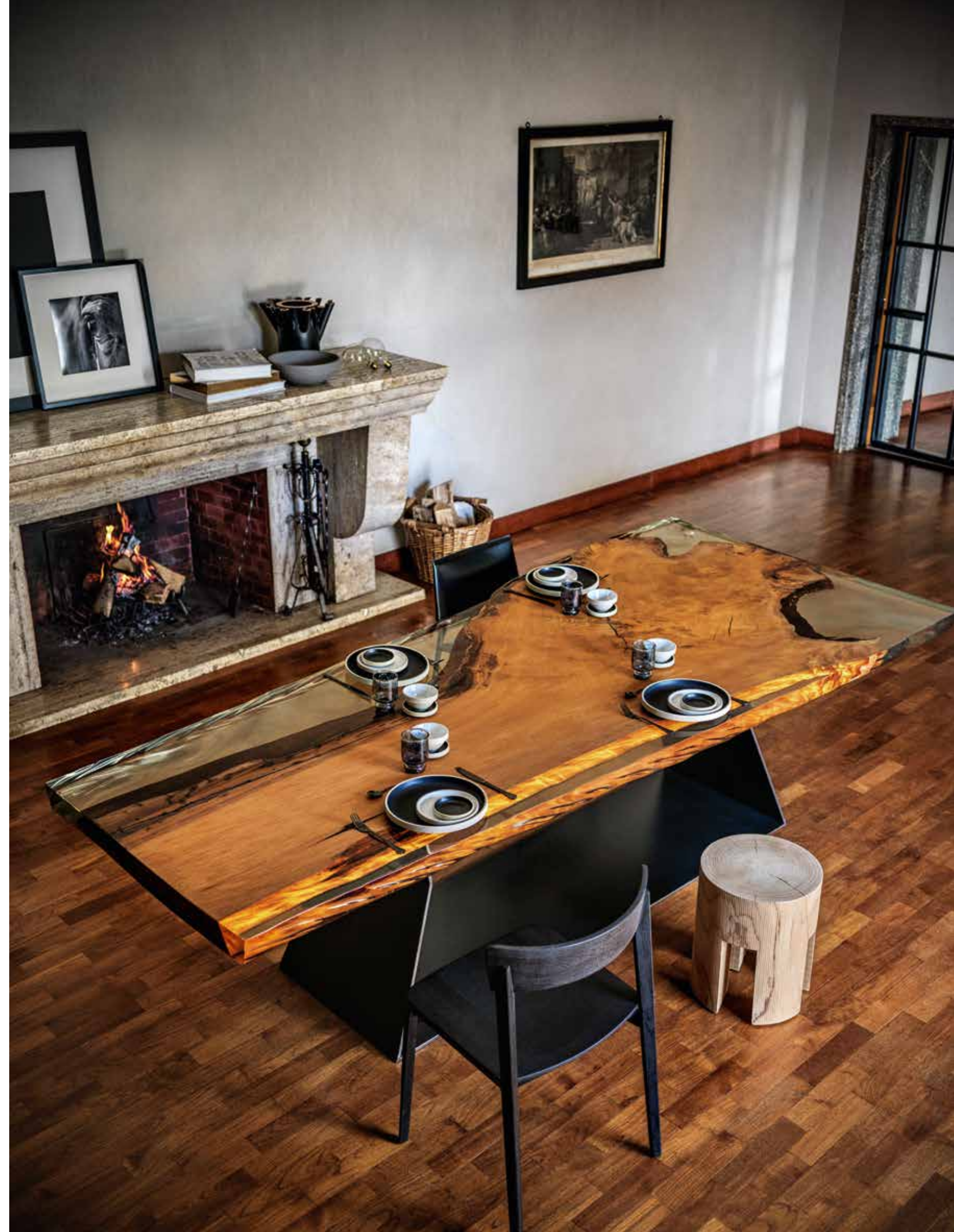







## KAURI BREE E ONDA

PASSON E SAVORGNANI



CM: L. 240/400 · P. 100/140 · H. 76

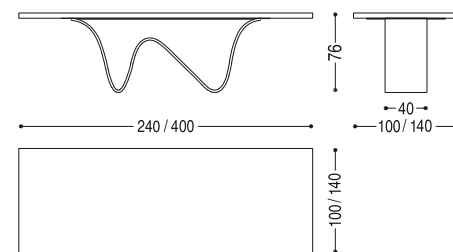

Tavolo realizzato con top in massello di Kauri, abbinato ad una particolare gamba dotata di forma sinuosa che ricorda le onde del mare.

*Table made with top in solid Kauri, combined with a particular leg characterised by a sinuous shape that brings to mind the sea waves.*

*Tisch bestehend aus einer Platte aus Kauriholz und einem originellen Gestell, das an die Meereswellen erinnert.*









## KAURI CIAK

GABRIELE E GIULIANO CAPPELLETTI



CM: L. 240/400 · P. 110/160 · H. 75

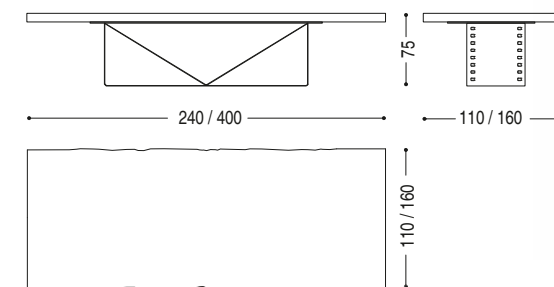

Tavolo realizzato con top in massello di Kauri e base geometrica in ferro calandrato il cui design si ispira alla pellicola cinematografica.

*Table made with top in solid Kauri, combined with a geometric base made of calendered iron, whose design is inspired to the cinematographic film.*

*Tisch mit Platte aus Kauriholz und geometrischem Untergestell aus gebogenem Eisen, dessen Design an Kinofilmen inspiriert ist.*





# KAURI CUBE

C.R.&S. RIVA1920



CM: L. 240/360 · P. 100/160 · H. 75

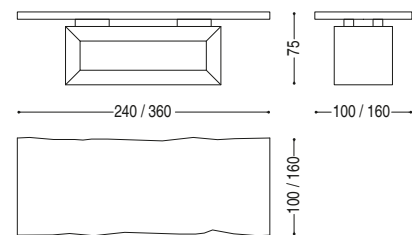

Tavolo realizzato con top in massello di Kauri, abbinato ad una base in ferro con sezione a slitta e saldature a vista.

*Table made with top in solid Kauri, combined with an iron base with squared section and visible welding.*

*Tischplatte bestehend aus Kauriholz und Untergestell aus Natureisen mit sichtbaren Schweißnähten.*











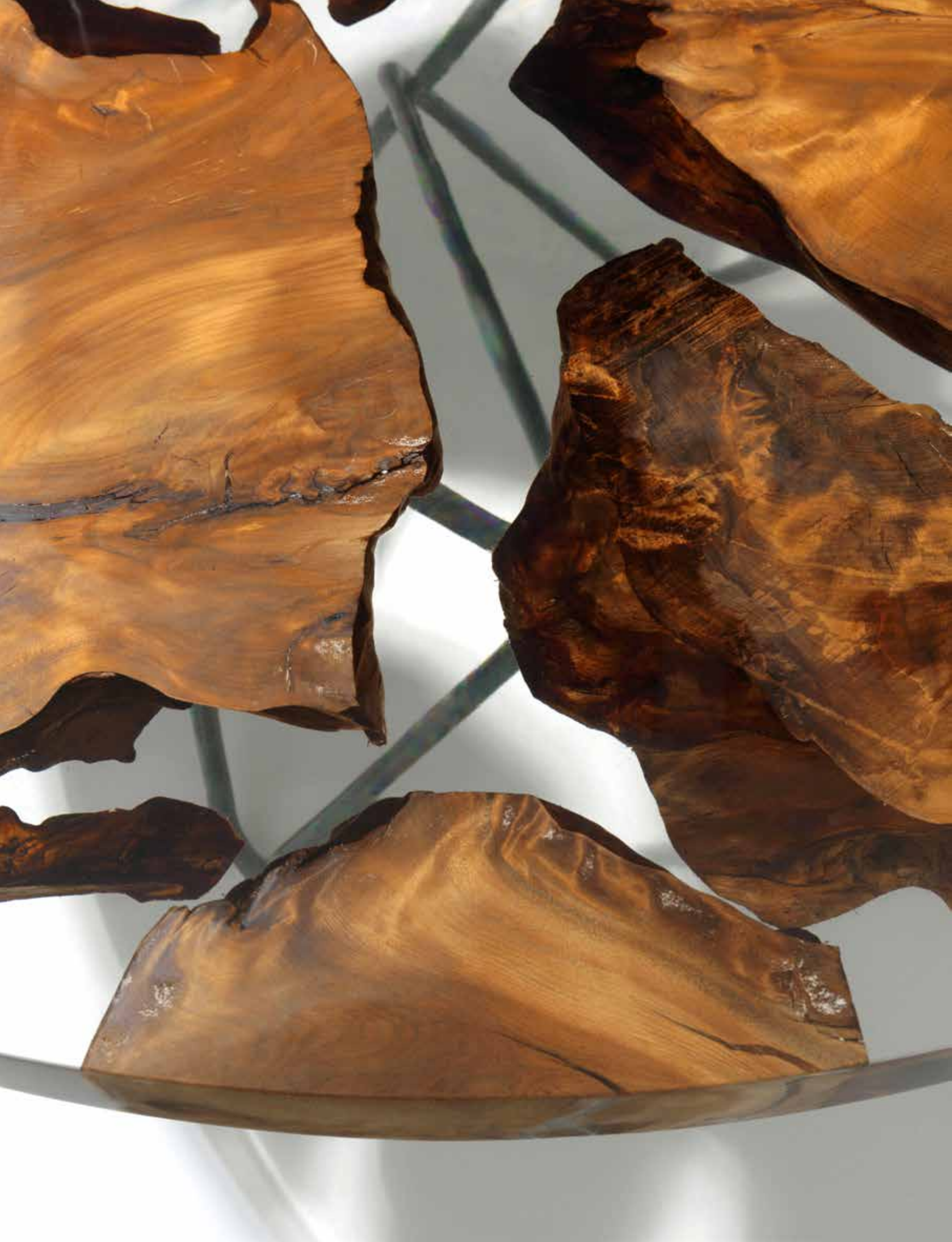

## KAURI EARTH

C.R.&S. RIVA1920 (TOP) / RENZO E MATTEO PIANO (BASE)



Earth si caratterizza per un top in resina e legno millenario di Kauri, vuole essere una rappresentazione stilizzata del globo terrestre, metaforicamente le parti in legno rappresentano i continenti e le sezioni in resina gli oceani. Matericità del legno e trasparenza della resina sono in grado di creare un suggestivo gioco di luci ed ombre. La particolare base in ferro scuro, con sezione tubolare e saldature a vista, disegnata da Renzo e Matteo Piano e che riprende il progetto originale del tavolo "Antico" per l'iniziativa Ground Zero..Ground Heroes simboleggia il groviglio delle armature degli edifici che fuoriuscivano dalle macerie in seguito al crollo delle Torri Gemelle.

*Earth is characterised by a top made of resin and pieces of ancient Kauri wood: it is conceived to be a stylized symbol of the Earth as it was in the origin; in fact the wood pieces represent the continents and the resin parts the oceans. The colour of the wood and the transparency of the resin are able to create a special trick of lights and shadows. The peculiar base in dark iron, with tubular section and visible weld joints, was designed by Renzo and Matteo Piano and is inspired to the original project of the table "Antico" for the initiative Ground Zero... Ground Heroes; in fact it represents the nest of metal rebars remained after the Twin Towers collapsed.*

*Der Tisch kennzeichnet sich durch seine besondere Tischplatte aus tausendjährigem Kauriholz und Kunstharz, die eine stilisierte Wiedergabe der Erdkugel sein will, in der die Holzteile die Kontinente und das Kunstharz die Ozeane darstellen. Die Transparenz des Kunstharzes und die Kombination mit Holz schaffen ein faszinierendes Spiel von Licht und Schatten zu. Das Rohrgestell aus Natureisen mit sichtbaren Schweißnähten wiederholt das Originalprojekt des Tisches „Antico“ vom Arch. Renzo und Matteo Piano für die Initiative Ground Zero... Ground Heroes und erinnert an die Gerüste von den Gebäuden, die sich im Folge des Zusammenbruches der Twin Towers aus den Trümmern erhoben.*

CM: Ø 130/190 · H. 75

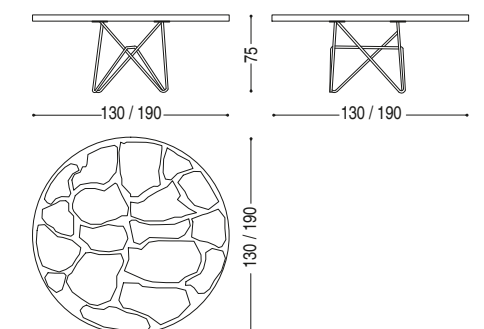







## KAURI EARTH SQUARE

C.R.&S. RIVA1920 (TOP) / RENZO E MATTEO PIANO (BASE)



Earth square è una rivisitazione del progetto originale che vede il top sviluppato nella forma quadrata invece che tonda. Il top in resina e legno millenario di Kauri, vuole essere una rappresentazione stilizzata del globo terrestre, metaforicamente le parti in legno rappresentano i continenti e le sezioni in resina gli oceani. Matericità del legno e trasparenza della resina sono in grado di creare un suggestivo gioco di luci ed ombre. La particolare base in ferro scuro, con sezione tubolare e saldature a vista, disegnata da Renzo e Matteo Piano e che riprende il progetto originale del tavolo "Antico" per l'iniziativa Ground Zero...Ground Heroes simboleggia il groviglio delle armature degli edifici che fuoriuscivano dalle macerie in seguito al crollo delle Torri Gemelle.

*Earth square is a reinterpretation of the original project that proposes the top developed in square rather than in round shape. It is characterised by a top made of resin and pieces of ancient Kauri wood: it is conceived to be a stylized symbol of the Earth as it was in the origin; in fact the wood pieces represent the continents and the resin parts the oceans. The colour of the wood and the transparency of the resin are able to create a special trick of lights and shadows. The peculiar base in dark iron, with tubular section and visible weld joints, was designed by Renzo and Matteo Piano and is inspired to the original project of the table "Antico" for the initiative Ground Zero...Ground Heroes; in fact it represents the nest of metal rebars remained after the Twin Towers collapsed.*

CM: L. 130/190 - P. 130/190 - H. 75

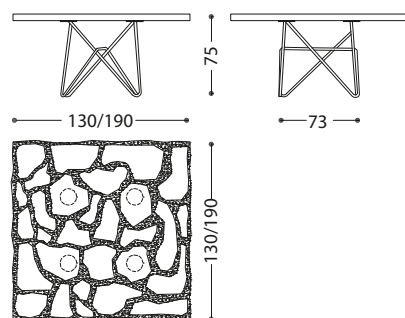

*Earth Square ist die Entwicklung vom Tisch Earth jedoch in quadratischer Form anstatt rund. Der Tisch kennzeichnet sich durch seine besondere Tischplatte aus tausendjährigem Kauriholz und Kunstharz, die eine stilisierte Wiedergabe der Erdkugel sein will, in der die Holzteile die Kontinente und das Kunstharz die Ozeane darstellen. Die Transparenz des Kunstharzes und die Kombination mit Holz schaffen ein faszinierendes Spiel von Licht und Schatten zu. Das Rohrgestell aus Natureisen mit sichtbaren Schweißnähten wiederholt das Originalprojekt des Tisches „Antico“ vom Arch. Renzo und Matteo Piano für die Initiative Ground Zero... Ground Heroes und erinnert an die Gerüste von den Gebäuden, die sich im Folge des Zusammenbruches der Twin Towers aus den Trümmern erhoben.*

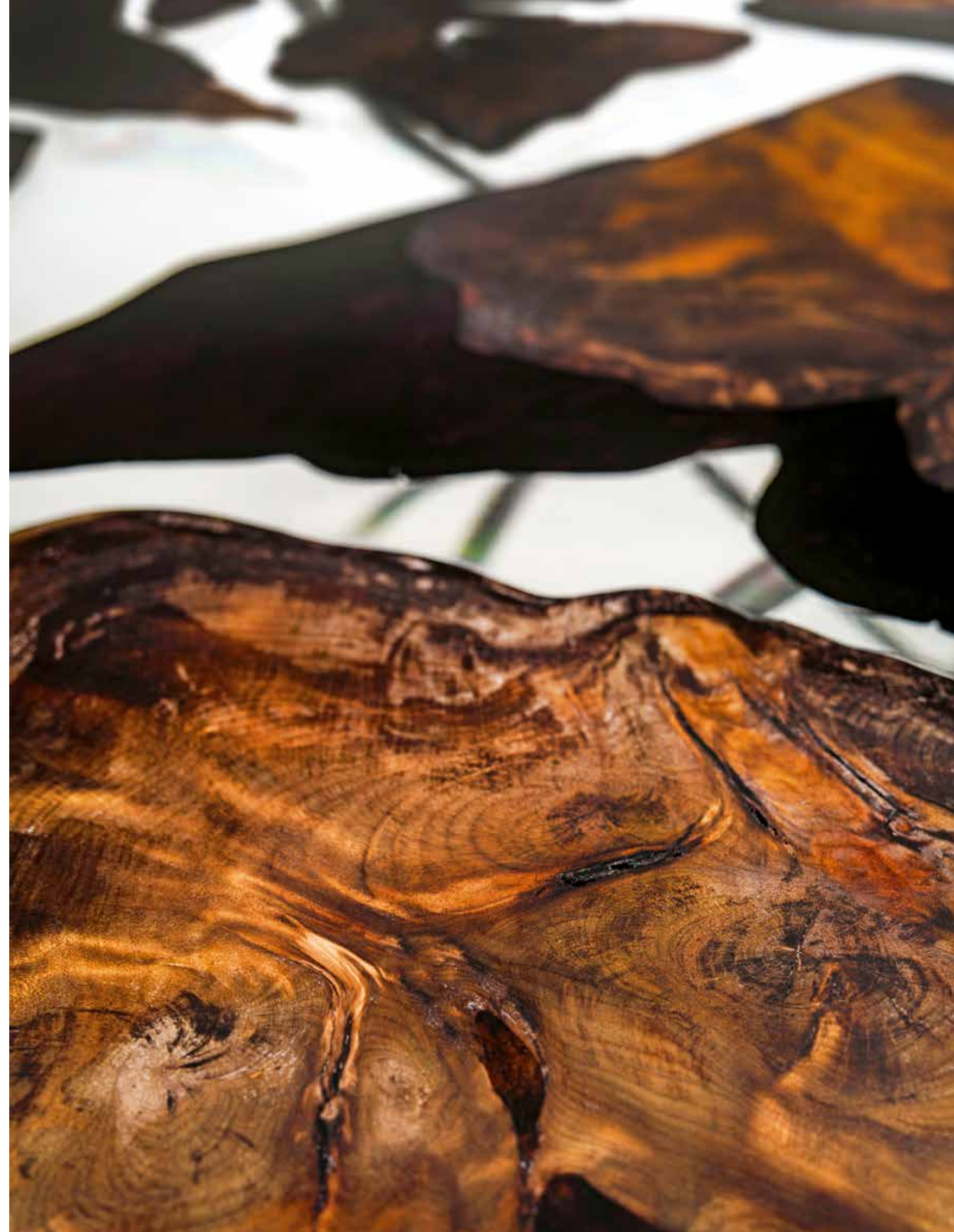





## KAURI NEWTON

C.R.&S. RIVA1920

Tavolo realizzato con top in massello di Kauri. La base si compone di gambe in ferro con saldature a vista.

*Table made with top in solid Kauri, combined with an iron base with visible welding.*

*Tisch bestehend aus einer Platte aus Kauriholz und einem Natureisengestell mit sichtbaren Schweißnähten.*

CM: L. 220/400 · P. 100/160 · H. 75

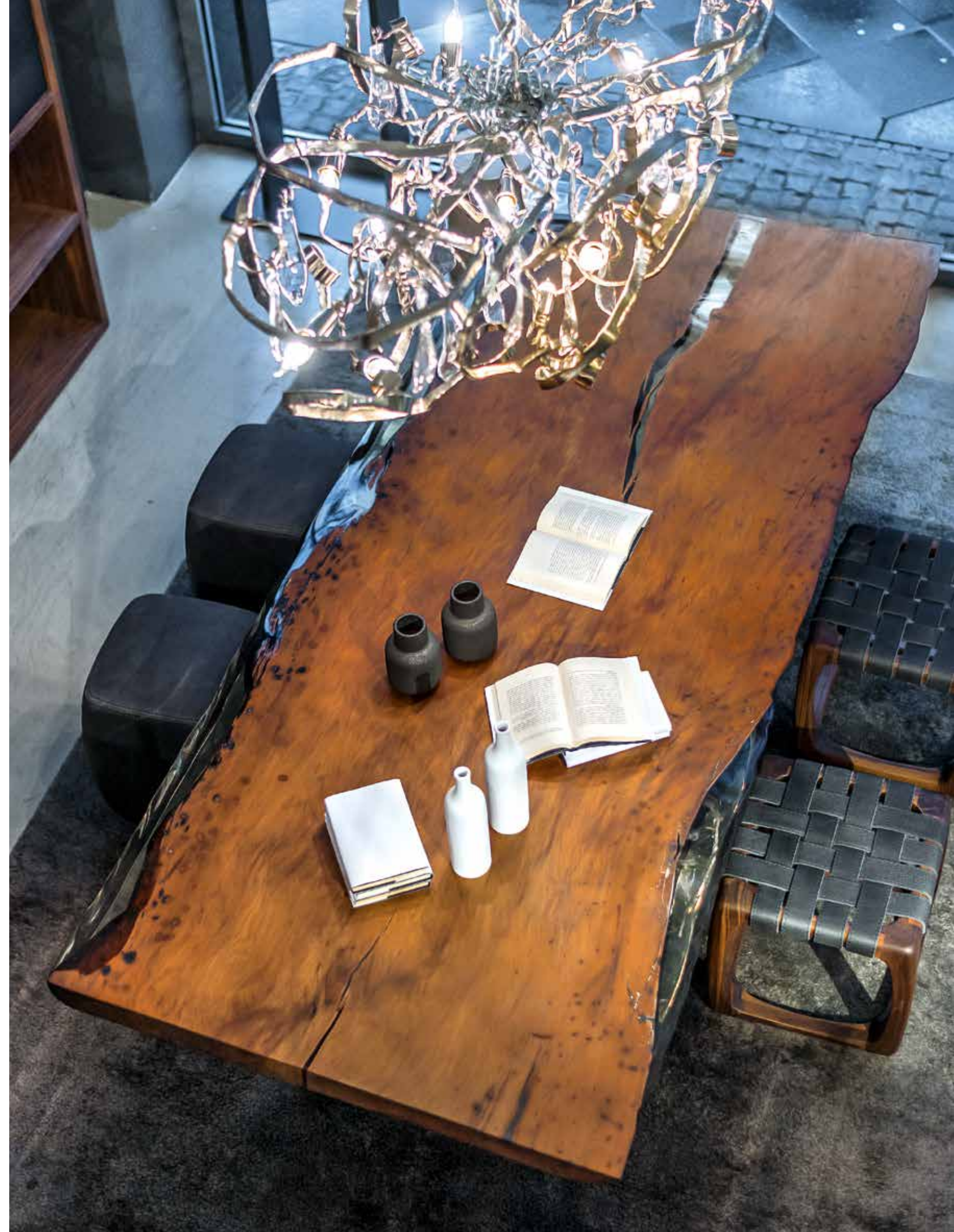
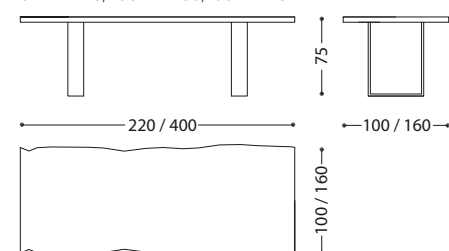



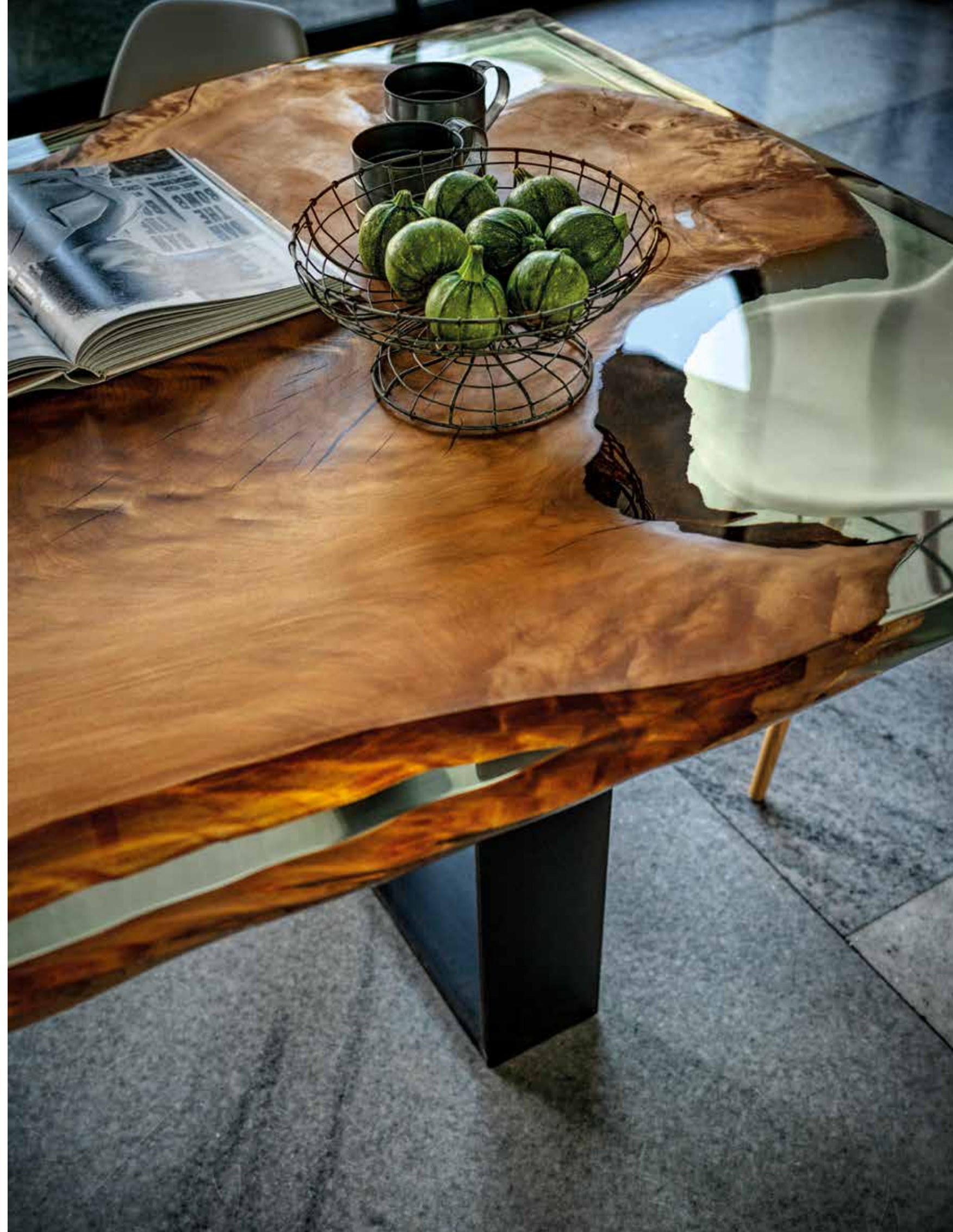









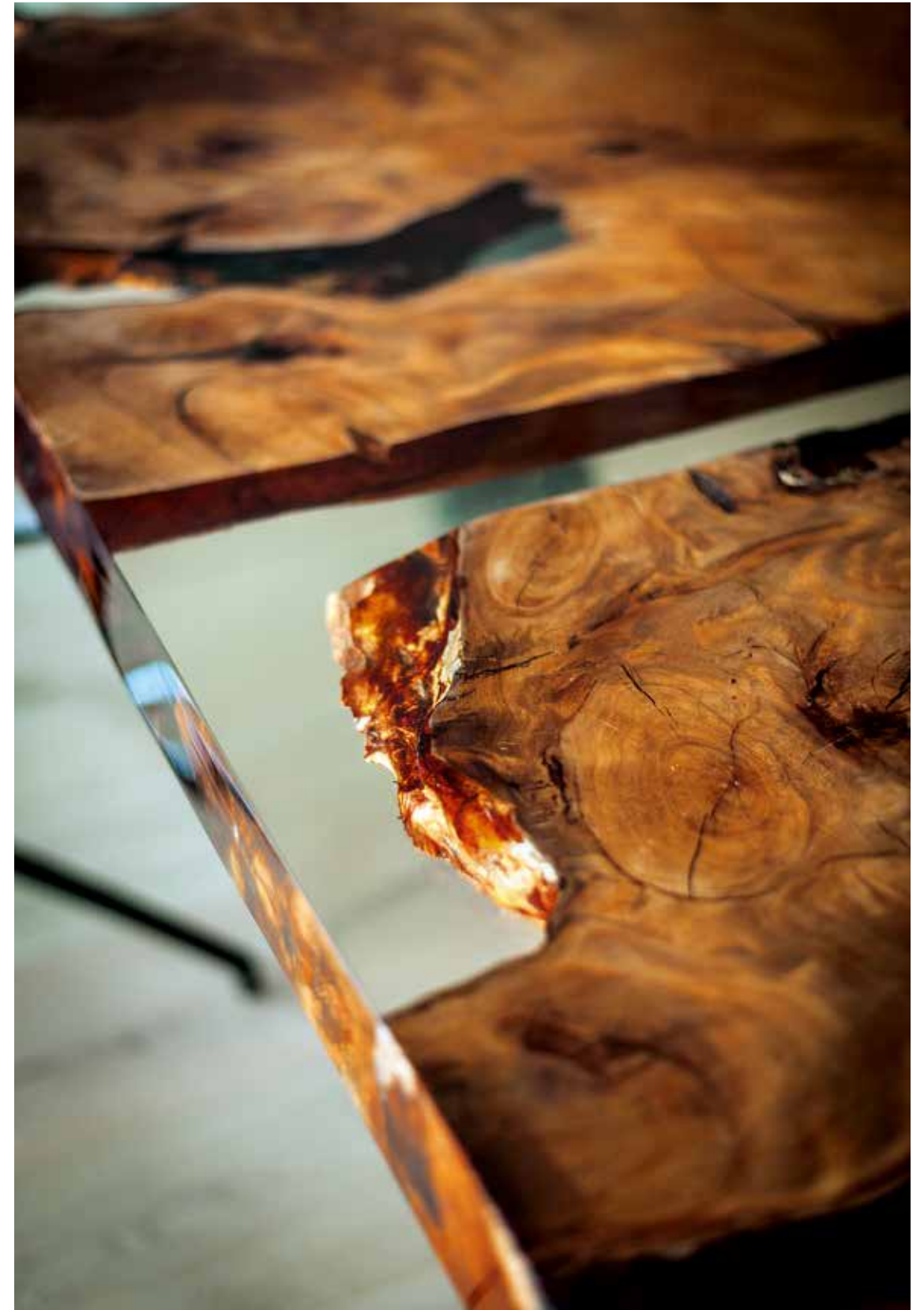



# KAURI PIANO ANTICO

RENZO E MATTEO PIANO



CM: L. 240/360 · P. 100/120 · H. 77,5

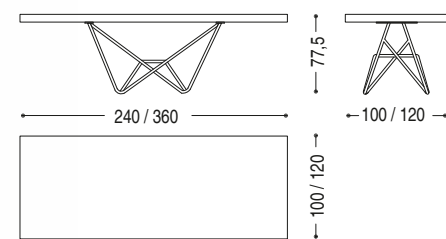

Tavolo realizzato con top in massello di Kauri, abbinato ad una base in ferro scuro con sezione tubolare e saldature a vista.

*Table made with top in solid Kauri, combined with a dark iron base with tubular section and visible welding.*

*Tisch bestehend aus einer Platte aus Kaurholz und Gestell aus dunklen Eisenrohren mit sichtbaren Schweißnähten.*



## KAURI RIFLESSI MILLENARI

HELIDON XHIXHA



CM: L. 240/400 · P. 100/140 · H. 75

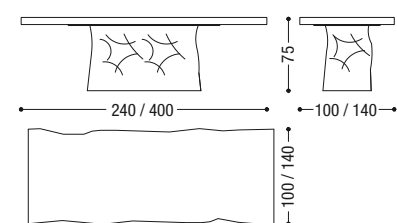

Tavolo realizzato con top in massello di Kauri, con base scultorea realizzata con fogli d'acciaio forgiati dall'artista di fama internazionale Helidon Xhixha.

*Table made with top in Kauri wood, with sculptural base made of steel sheets forged by the internationally renowned artist Helidon Xhixha.*

*Tisch bestehend aus einer Tischplatte aus Kauriholz und einem Gestell aus Edelstahl vom weltbekannten Künstler Helidon XhiXha.*





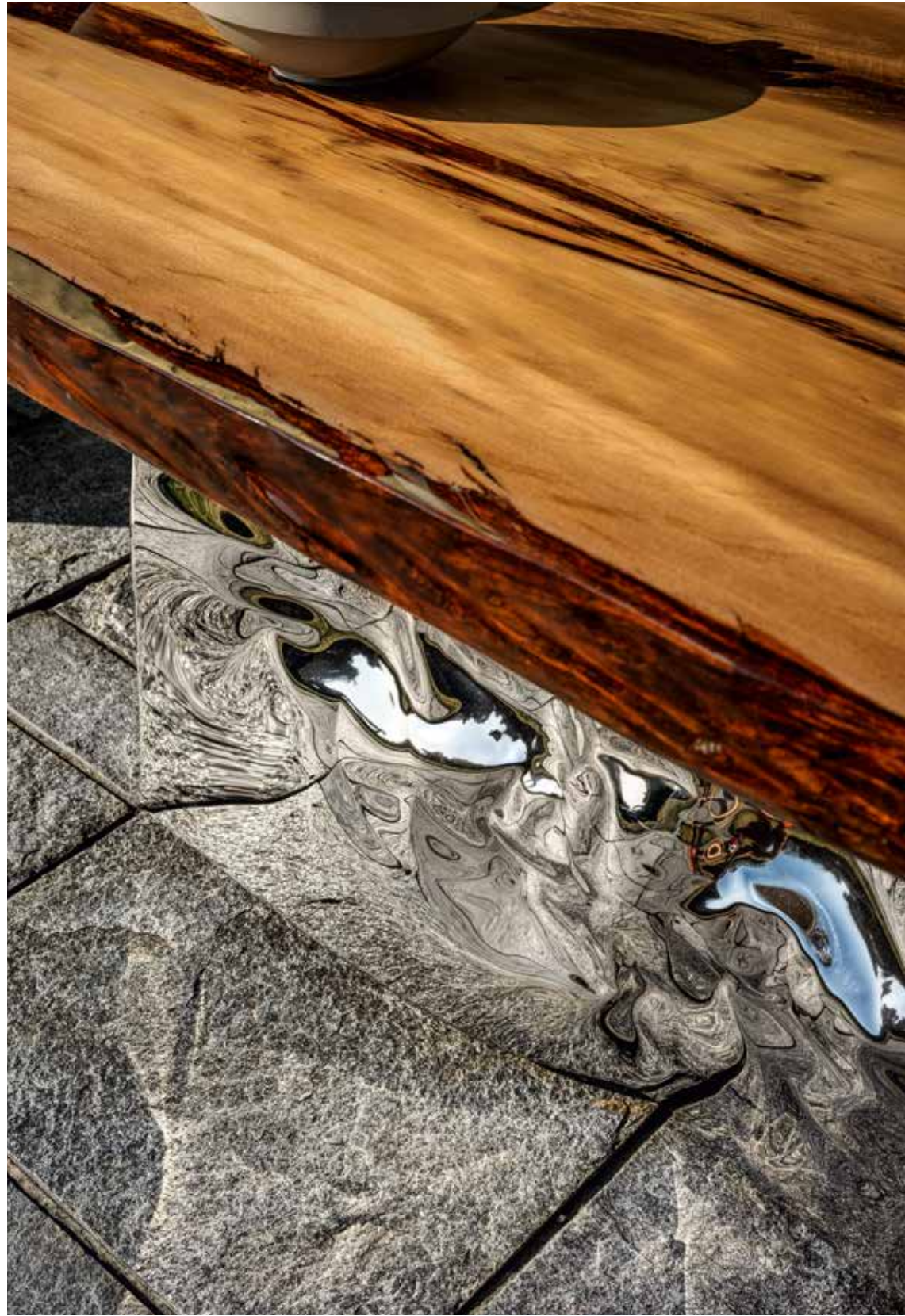





TAVOLINI · *SMALL TABLES* · *COUCHTISCHE*



**AUCKLAND BLOCK KAURI** 118-119



**TINY EARTH** 120-121



**KAURI STUMP** 122-135

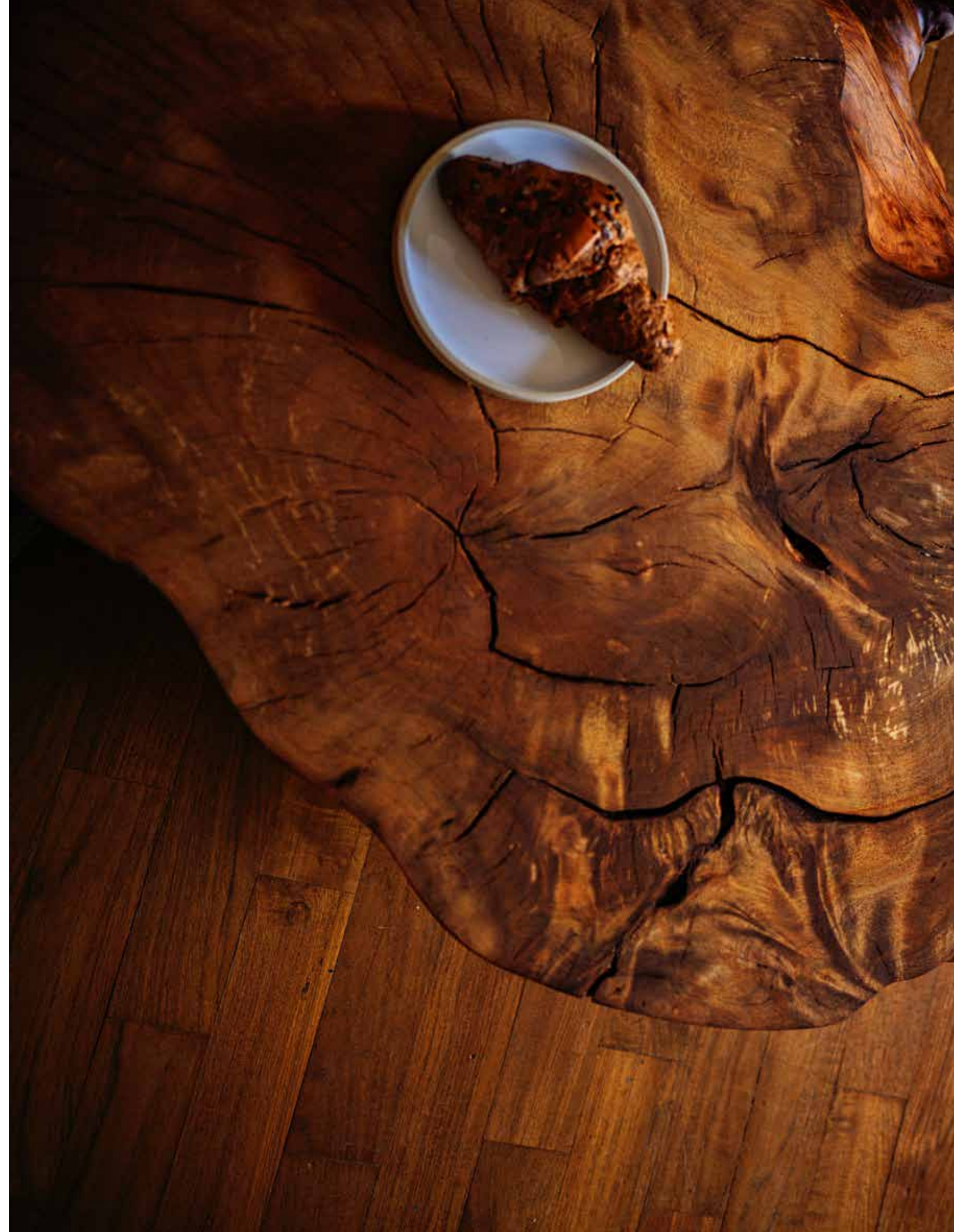

# AUCKLAND BLOCK KAURI

C.R.&S. RIVA1920



CM: L. 120 · P. 90 · H. 40

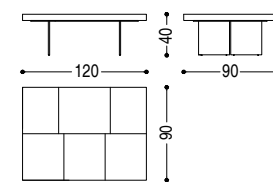

CM: L. 100/120/140 · P. 100/120/140 · H. 40

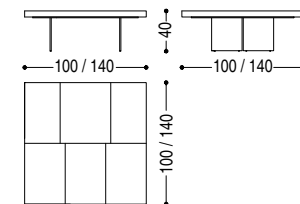

Tavolino realizzato con top in massello di Kauri, composto da blocchi squadri con venature contrapposte. Basamento in ferro naturale.

*Coffee table with a top in solid Kauri, consisting of squared blocks with contrasting grain. Natural iron base.*

*Coufisch mit Platte aus rechteckigen Kauriholzblöcken, mit Maserung in gegensätzlichen Richtungen, und Gestell aus Natureisen.*

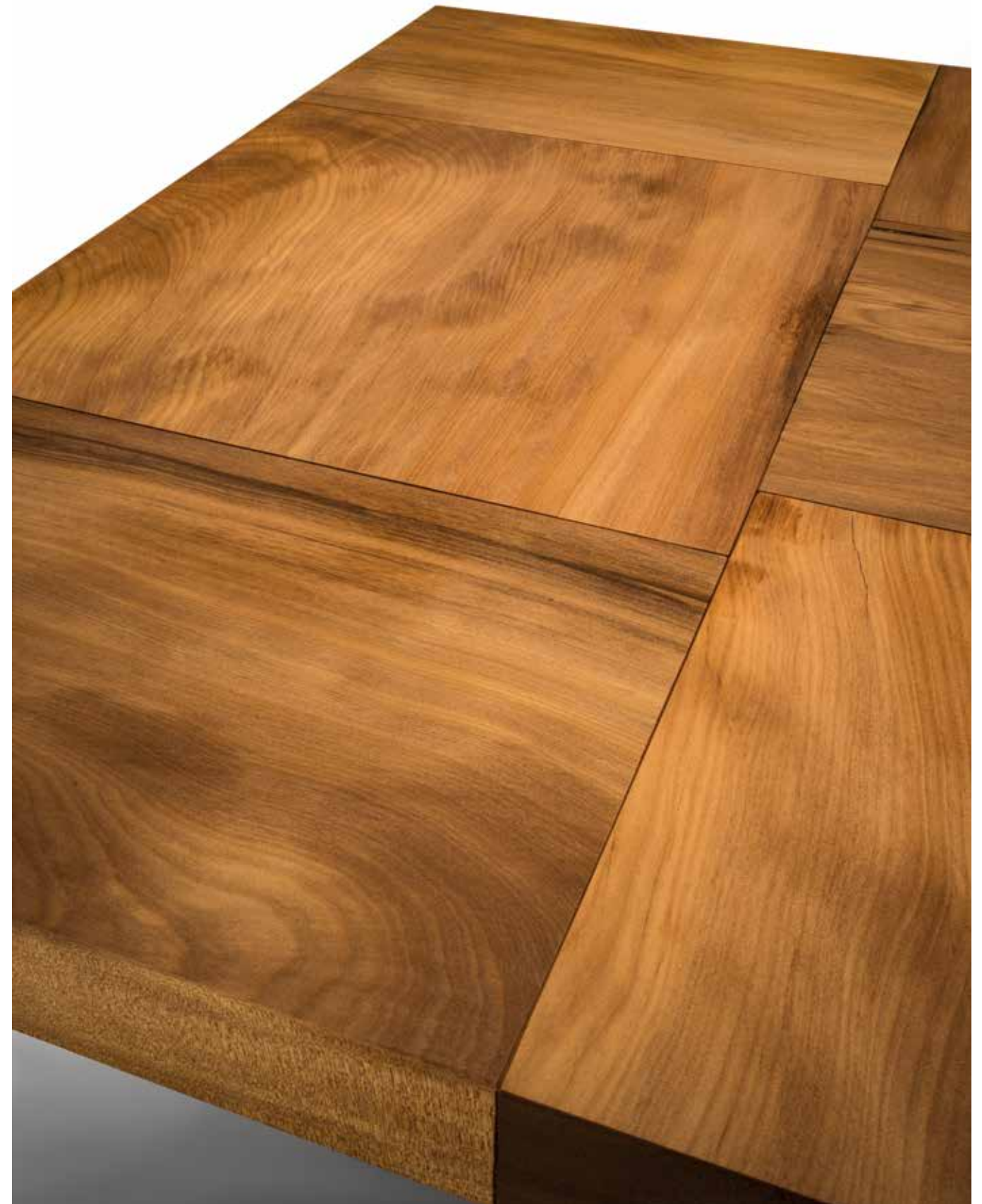



## TINY EARTH

C.R.&S. RIVA1920

Versione "side table" del tavolo Earth, si caratterizza per un top composto da frammenti di Kauri e resina. Il basamento in ferro si caratterizza per un design originale che punta sulla asimmetria della gamba centrale.

*Small version of the Earth table, which is featured by a top in Kauri wood blocks and resin. The iron base features an original design with asymmetrical leg.*

*Kleine Version des Tisches Earth mit Platte aus Kauriholzblöcken und Kunstharz. Gestell mit originellem asymmetrischem Design.*

CM: Ø 50 · H. 60

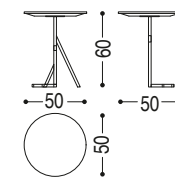

## KAURI STUMP

C.R.&S. RIVA1920



Tavolino completamente realizzato da una sezione trasversale di testa di massello di Kauri.

*Small table completely made of solid kauri wood, cross head-cut section of the kauri log.*

*Couchtisch aus einem Kauri Massivholzquerschnitt.*

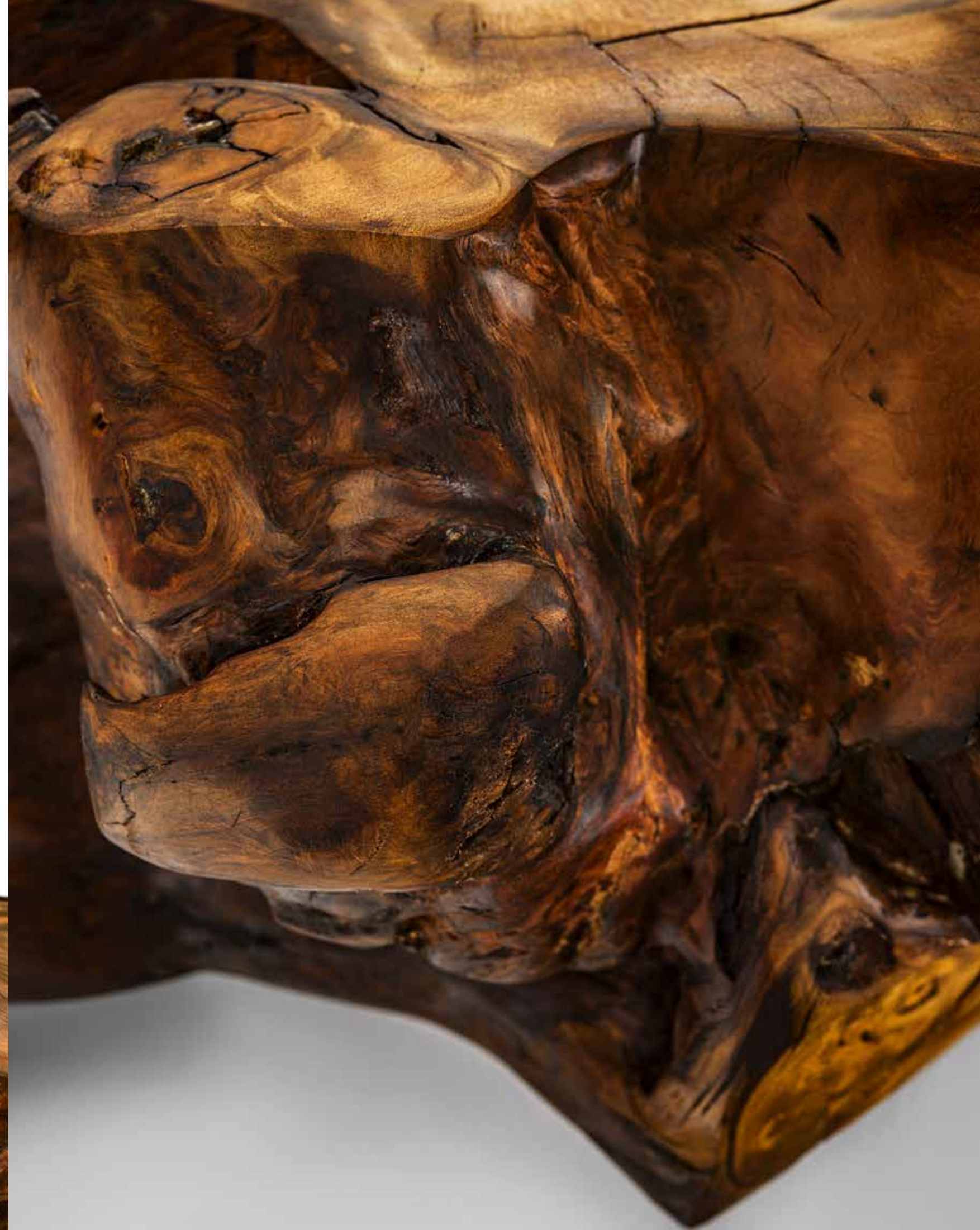











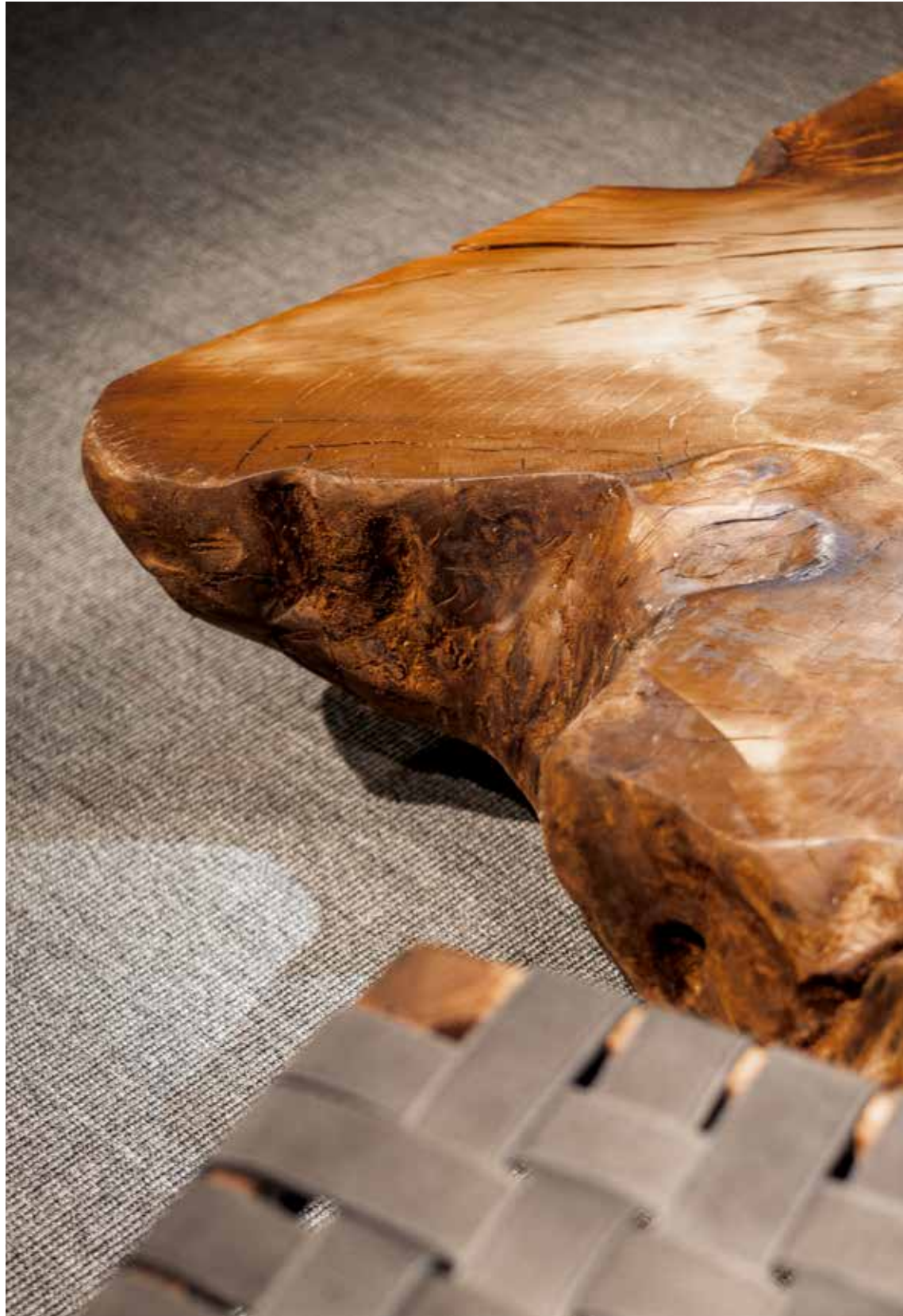



# KAURI: ART & SPECIALS

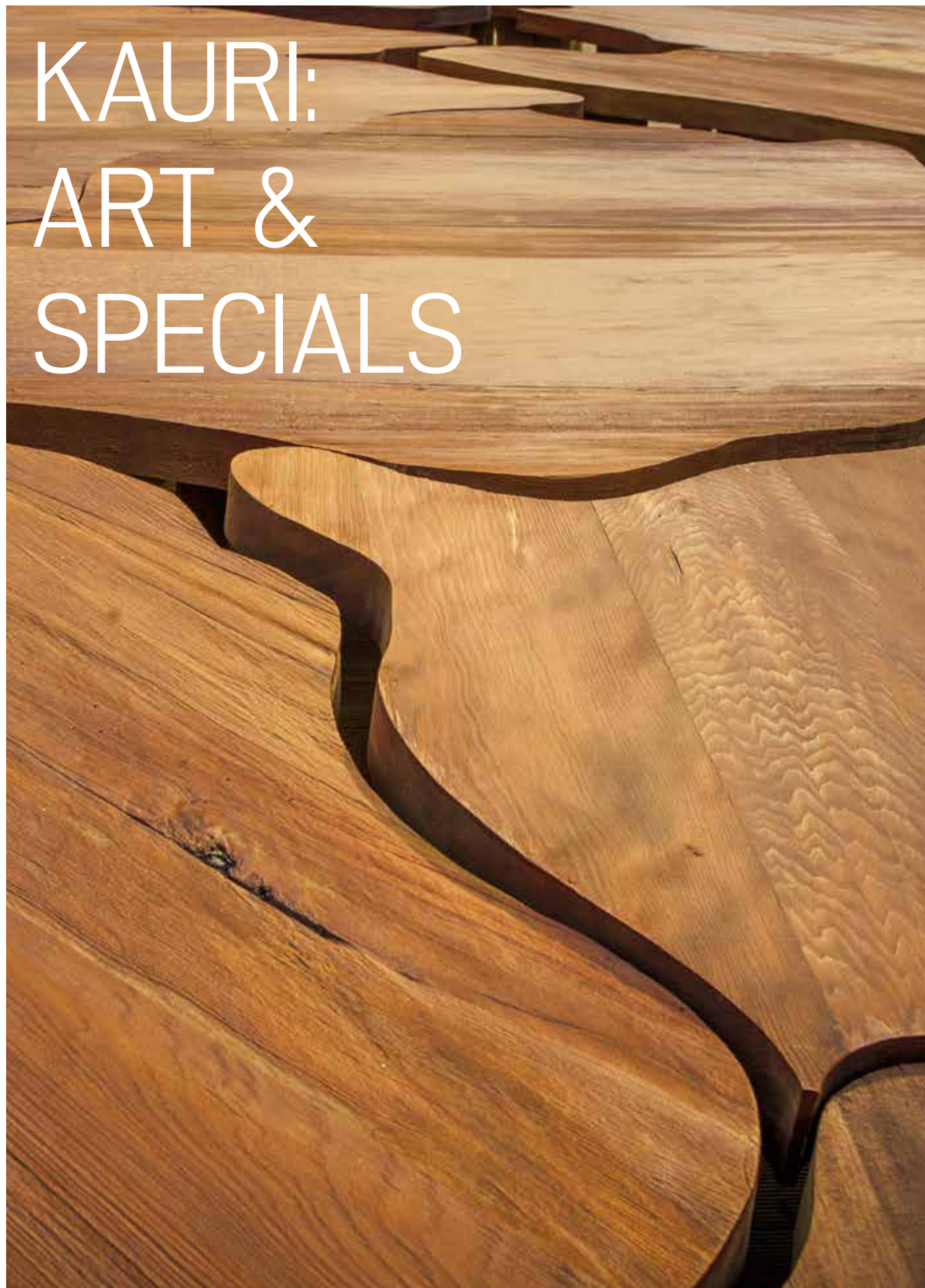

## MUSEO DEL LEGNO

Protagonista indiscusso del Museo del Legno di Riva 1920 è il tavolo "Antico" in legno millenario di Kauri datato 48.000 anni e lungo 12 metri, caratterizzato da una base in ferro disegnata dall'architetto Renzo Piano. Lo spazio accoglie altresì un'esposizione di oltre 5.000 pezzi tra macchine ed utensili per la lavorazione del legno (datazione 1850/1930). Una collezione unica nel suo genere in Europa per la quantità di pezzi presenti. L'esposizione ha l'obiettivo di far riscoprire le origini e le tradizioni tipiche dell'ebanisteria, annovera molti utensili provenienti da antiche botteghe artigiane italiane. Nell'ampio salone si trovano pialle, banchi da lavoro, torni, combinate, pulitrici, seghe a nastro, bindelle: termini tecnici quasi dimenticati.

## MUSEUM OF WOOD

*Undisputed centerpiece of the Museum of Wood is the table "Antico" in Kauri wood aged 48,000 years and 12 meters long, featuring an iron base designed by Renzo Piano. The space also displays over 5,000 pieces including woodworking machines and tools (dating 1850/1930).*

*A unique collection of its kind in Europe for its number of pieces. The exhibition, which aims to rediscover the origins and traditions typical of cabinet making, includes several tools coming from ancient Italian artisan workshops. In the large lounge space, there are single cylinder planers, work benches, machine centers, polishing machines, belt saws, technical terms almost forgotten.*

## HOLZMUSEUM

*Unbestrittene Hauptfiguren dieses Raumes ist der Tisch „Antico“ aus tausendjährigem Kauriholz, 48.000 Jahre alt und 12 Meter lang, mit einem Gestell aus Eisenrohren, das vom Architekt Renzo Piano gezeichnet wurde. Im Holzmuseum befinden sich über 5.000 Ausstellungsstücke, Maschinen und Werkzeugen zur Holzbearbeitung aus dem Zeitraum 1850/1930, eine einzigartig große Sammlung dieser Art in Europa. In der Ausstellung können der Ursprung und die typischen Traditionen der Kunstschlerei wieder entdeckt werden, dank vielen Werkzeugen aus alten italienischen Schreinerwerkstätten. In der geräumigen Ausstellung werden Hobel, Werk und Drehbänke, Kombimaschinen, Poliermaschinen, Bandsägen gezeigt: Fachausdrücke, die fast vergessen sind.*



## PANGEA LAB · EXPO 2015

Il tavolo Pangea, simbolo di Expo Milano 2015, a firma di Michele De Lucchi, si ispira all'unico continente che in origine si ritiene includesse tutte le terre emerse e che durante le successive ere geologiche si è diviso nei vari continenti. La superficie di 80 metri quadrati realizzata in Kauri, datato 50.000 anni, è composta da 19 pezzi sagomati ed è sostenuta da 271 gambe realizzate in Briccola, pali di rovere recuperati della laguna di Venezia, esposto all'interno del Padiglione 0 progettato dallo stesso De Lucchi. Trova ora la sua collocazione all'interno del Pangea Lab, spazio didattico e formativo la cui finalità è quella di far conoscere da vicino lavorazioni e materiali attraverso l'organizzazione di workshop dedicati a studenti ed addetti al settore. Lungo tutte le pareti sono poste una xiloteca raccolta di legni provenienti da tutto il mondo e una selezione di materiali naturali tra i quali: pelli, marmi, metalli, vetri e tessuti raccolti in apposite teche di vetro.

*The table Pangea, symbol of Expo 2015, design by Michele de Lucchi, is inspired to the single continent that was once believed to include all the emerged lands and that during the subsequent geological ages was divided in different continents. The surface of 80 square meters made of Kauri wood, aged 50.000 years, is composed of 19 shaped pieces and supported by 271 legs made of Briccola, oak poles coming from the Venetian Lagoon; this table was exhibited inside the Pavillon Zero, conceived by Michele de Lucchi. Now it is in our Pangea lab, an educational and training space whose purpose is to get acquainted with processing and materials thanks to workshops for students and professionals. All along the walls there is a xylotheque, a collection of wood samples coming from all over the world and a selection of natural materials such as: leather, marble, metals, glass and fabrics collected in special glass display cases.*

*Der Tisch Pangea, Symbol der Expo 2015, wurde von Michele de Lucchi entworfen und inspiriert sich am einzigen Kontinent, der zu Beginn das ganze Festland enthielt, welches sich in den nachfolgenden geologischen Epochen in die verschiedenen Kontinente getrennt hat. Er hat eine Oberfläche von 80 Quadratmetern und wurde aus Kauriholz hergestellt, 50.000 Jahre alt; die Tischplatte besteht aus 19 Formteilen, die durch 271 Tischbeine aus Briccola getragen werden, Eichenholzpfähle aus der Lagune von Venedig. Dieser Tisch wurde im Padiglione 0 in Expo ausgestellt (design Michele de Lucchi). Jetzt ist der Tisch in unser Pangea Lab ausgestellt; Pangea Lab ist ein Bildungs- und Trainingsplatz, dessen Ziel ist die Materialien und die Prozesse durch Workshops für Studenten und Fachleute bekanntzumachen. Entlang der Wände befindet sich eine Xylotheke, eine Sammlung von Hölzern aus der ganzen Welt und eine Auswahl natürlicher Materialien, wie Leder, Marmor, Metall, Glas und Stoffe, die in Glasvetrinen gesammelt werden.*



Expo Milano 2015

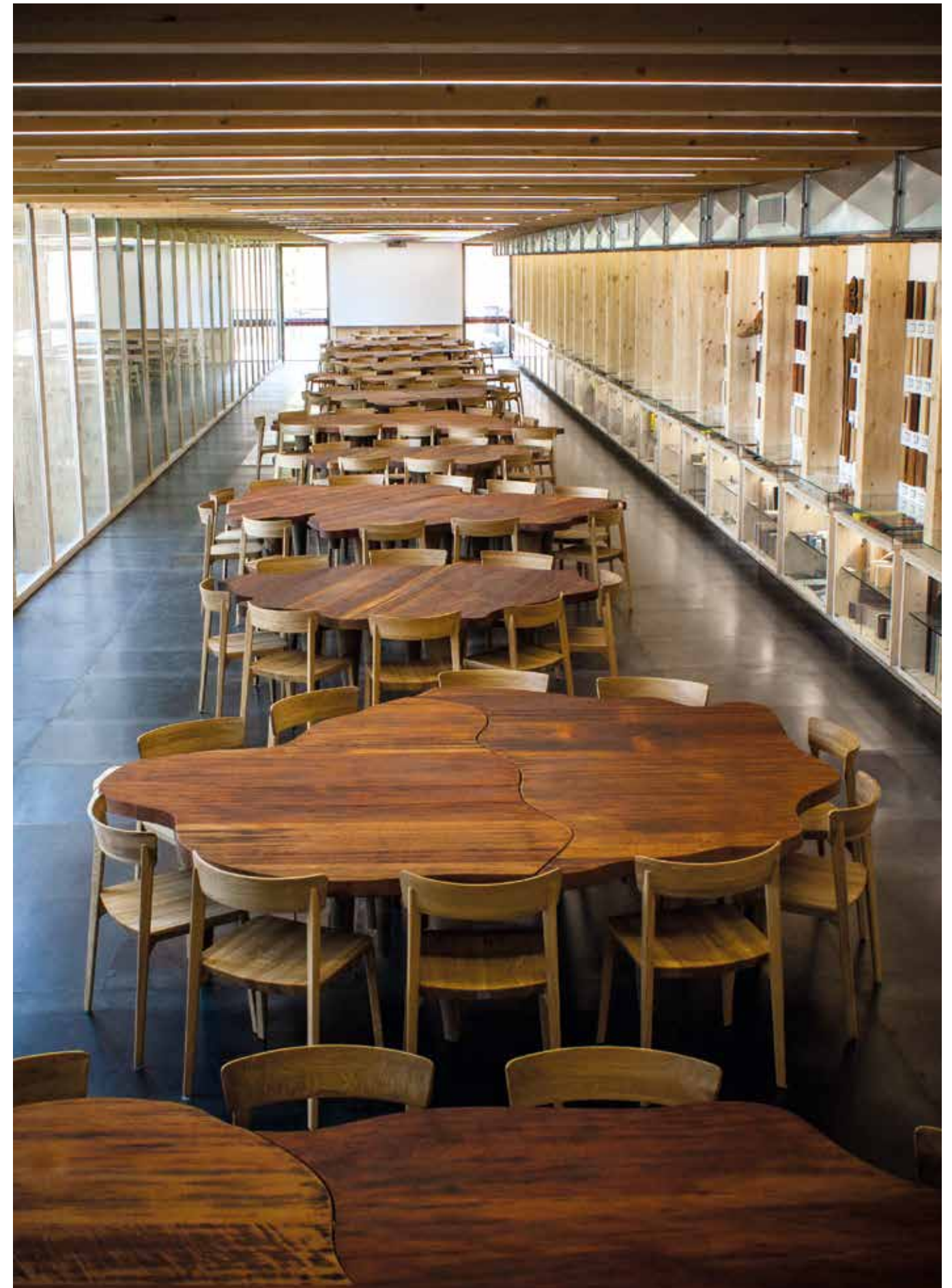

Pangea Lab

## TIMELESS · ECCELLENZE ITALIANE UNITE PER UN TAVOLO SENZA TEMPO

Timeless è un tavolo di 5 metri con top in massello di Kauri, legno millenario della Nuova Zelanda, con inserti in resina, e con base progettata dall'artista Helidon Xhixha. Quest'ultima si compone di due parti perfettamente integrate: il marmo bianco Statuario Altissimo, fornito da Henraux, e l'acciaio, molato e lucidato per ottenere l'effetto specchiante. Il piano del tavolo vede al suo interno l'inserimento di un orologio, realizzato da La Vallée, con meccanismo a vista, con un innovativo calendario perpetuo a ingranaggi.

Partners del progetto: Marco Piva, Massimiliano Schiavon Art Team, Davide Oldani, Rilegno, Cantine Ferrari, Eataly, Scm Group, Conterno Giacomo.

## TIMELESS · ITALIAN EXCELLENCES TOGETHER FOR AN EVER-LASTING TABLE

*Timeless is a 5 meters long table with top in solid Kauri, ancient wood from New Zealand, with resin inserts and base designed by the artist Helidon Xhixha. The base is made of two perfectly combined parts: one in "Statuario Altissimo" white marble, supplied by Henraux, and the other in stainless steel, polished to obtain a reflecting surface. Inside the table top is a timepiece, created by La Vallée, with exposed mechanism and an innovative eternal calendar gear.*

*Partners of the project are: Marco Piva, Massimiliano Schiavon Art Team, Davide Oldani, Rilegno, Cantine Ferrari, Eataly, Scm Group, Conterno Giacomo.*

## TIMELESS · ITALIENISCHE EXZELLEENTE FIRMEN FÜR EINEN ZEITLOSEN TISCH ZUSAMMEN

*Timeless ist ein 5-Meter lang Tisch mit Platte aus Kauri, tausendjährigem Holz aus Neuseeland, mit Kunstharzeinsätzen und Gestell vom Künstler Helidon Xhixha. Dieses Gestell besteht aus 2 perfekt kombinierten Teilen: der weiße Marmor „Statuario Altissimo“, von der Firma Henraux versorgt, und der polierte Edelstahl, der ein reflektierendes Effekt hat. Die Tischplatte enthält eine Uhr, von der Firma La Vallée, mit sichtbarem Mechanismus und einem originellen ewigen Kalender.*

*Andere Partners des Projektes sind: Marco Piva, Massimiliano Schiavon Art Team, Davide Oldani, Rilegno, Cantine Ferrari, Eataly, Scm Group, Conterno Giacomo.*







## "GROUND ZERO... GROUND HEROES"

La finalità del progetto "Ground Zero... Ground Heroes" è stata quella di dimostrare la solidarietà della famiglia Riva verso le famiglie delle vittime della tragedia delle Twin Towers, avvenuta l'11 Settembre 2001. Cinque i tavoli realizzati sotto la direzione di Davide e Maurizio Riva e firmati da alcuni tra i più importanti e sensibili progettisti contemporanei: Matteo e Renzo Piano, Mario Botta, Terry Dwan, Antonio Citterio e Pininfarina. Resi ancora più esclusivi dal materiale utilizzato: Kauri millenario, legno unico al mondo, che risale al periodo giurassico, l'essenza rara e antichissima datata oltre 50.000 anni così come il suo simboleggiare la rinascita, hanno assunto un significato profondo nella realizzazione di questo progetto. Il Kauri ha saputo sfidare il tempo, conservandosi intatto nel grembo delle terra e facendosi testimone silenzioso affinché l'orrore non sia dimenticato. I tavoli sono poi stati venduti all'asta donando il ricavato alle famiglie dei pompieri di New York che hanno perso la vita a Ground Zero, un gesto concreto a favore di una solidarietà autentica e sincera come il legno.

*The project "Ground Zero... Ground Heroes" has been promoted by Riva 1920 to show solidarity to the families of victims of the Twin Towers' tragedy, occurred on 11<sup>th</sup> September 2001. Five tables produced under the technical direction of Davide and Maurizio Riva and signed by some of the most important and sensitive contemporary designers: Matteo and Renzo Piano, Mario Botta, Terry Dwan, Antonio Citterio and Pininfarina. Even more exclusive thanks to the material chosen: Kauri, ancient wood of New Zealand, a unique type of wood that dates back to the Jurassic era. Its rare and antique essence, so as its symbolizing revival, gained a very deep meaning in the realization of this project. Kauri challenged time, preserving itself intact within the earth's womb, and it became a silent witness so that horror will not be forgotten. The five tables were sold during a charity auction and the revenue was entirely devolved in favor of the families of the New York Firemen, a concrete gesture for a solidarity as authentic and sincere as wood.*

*Das Ziel des Projektes "Ground Zero... Ground Heroes" bei RIVA 1920 war, Solidarität mit den Familien der Opfer der am 11. September 2001 geschehenen Tragödie der Twin Towers zu zeigen. Die fünf Tische, um welche Entwicklung die Gebrüder Davide und Maurizio Riva sich persönlich gekümmert haben, wurden von einigen der bedeutendsten weltbekanntesten modernen Designern entworfen: Matteo und Renzo Piano, Mario Botta, Terry Dwan, Antonio Citterio und Pininfarina. Sie gewinnen noch mehr am Wert, da sie mit dem einzigartigen Kauriholz hergestellt wurden, ein tausendjähriges Holz aus dem Jura. Dieses seltenes und uraltes Holz so wie auch seine Darstellung des Wiederauflebens hatten eine sehr spezielle Bedeutung in der Entwicklung dieses Projektes. Kauriholz hat die Zeit überlebt, da es sich unter der Erde ganz perfekt behalten hat, und bei dem Gebrauch für die Realisierung dieser Tische gilt dieses Material als stiller Zeuge einer Tragödie die nicht zu vergessen ist. Die fünf Tische wurden bei einer Auktion verkauft und die ganzen Spenden wurden zugunsten von den Familien der verstorbenen Feuerwehrmänner in New York gegeben. Eine konkrete Solidaritätsgeste, echt und ehrlich wie das Holz.*



ARCH. ANTONIO CITTERIO CM: L. 316 · P. 40 · H. 81



ING. PAOLO PININFARINA CM: L. 307 · P. 125 · H. 76

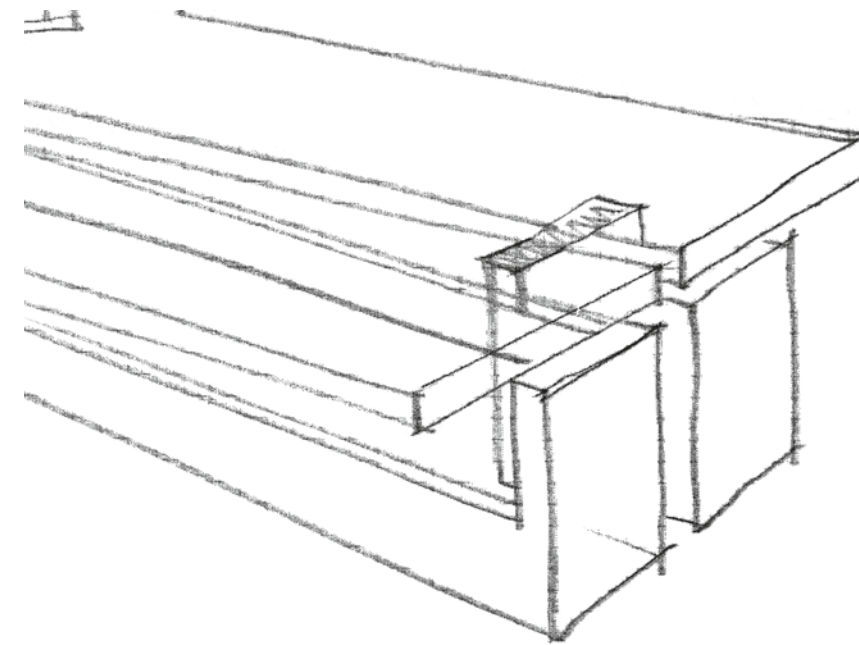

ARCH. MARIO BOTTA CM: L. 280 · P. 114 · H. 78

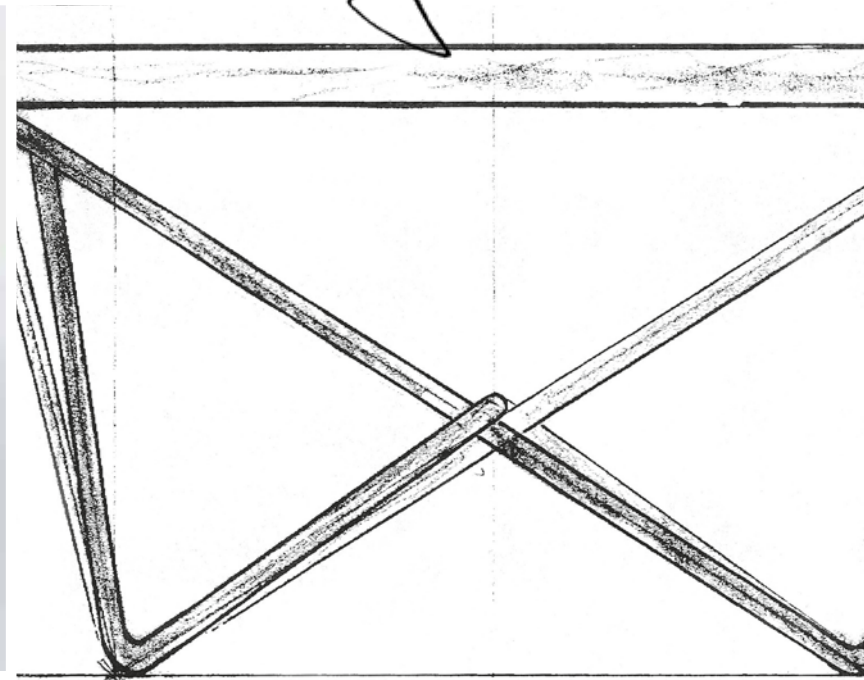

ARCH. RENZO E MATTEO PIANO CM: L. 280 · P. 120 · H. 74



ARCH. TERRY DWAN CM: L. 291 · P. 140 · H. 73

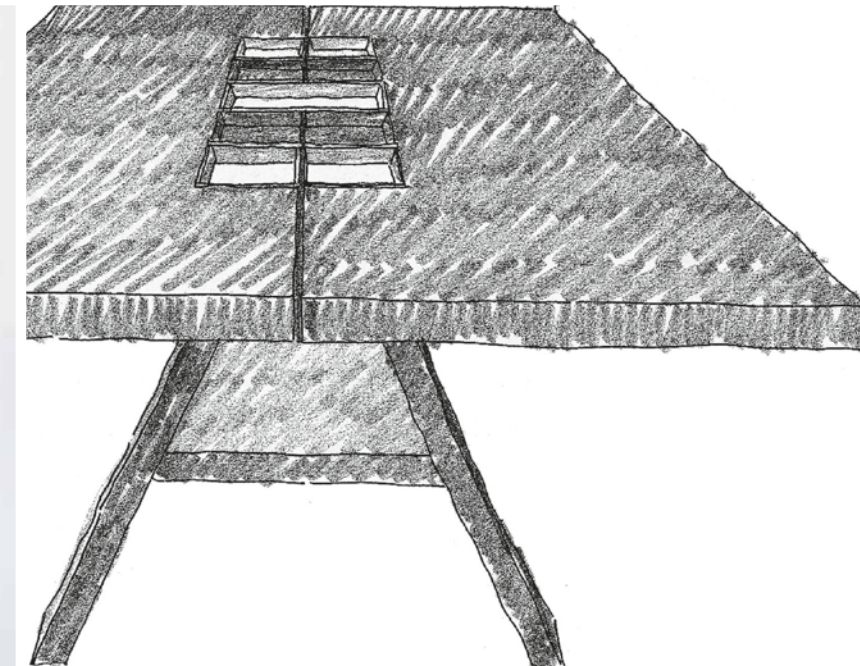



## CERTIFICATO DI AUTENTICITA'

Un prodotto realizzato in legno Kauri è sinonimo di esclusività, che garantisce al Cliente di possedere un manufatto con caratteristiche uniche e irripetibili.

Ecco perché a fronte dell'acquisto di un tavolo in Kauri, viene rilasciato un Certificato di Autenticità che determina l'età del legno con il quale è stato realizzato il tavolo.

La datazione di questo legno millenario, che varia dai 7.000 ai 50.000 anni, avviene attraverso l'analisi del Carbonio 14 effettuata dall'Università "La Sapienza" di Roma.

## CERTIFICATE OF AUTHENTICITY

*A product in Kauri wood is exclusive and guarantee for the Customer to own something with unique features.*

*That's why together with every Kauri table a Certificate of Authenticity is delivered, that shows the age of the wood used for production.*

*The wood is submitted to the carbon-14 dating at the laboratories in the University of "La Sapienza" and its age varies between 7.000 and 50.000 years.*

## ECHTHEITZERTIFIKAT

*Ein Produkt aus Kauriholz ist exklusiv und Garantie für den Kunden, ein echtes Unikat zu haben. Aus diesem Grund wird mit jedem Kauritisch ein Echtheitszertifikat mitgeliefert, was das Alter des Holzes bestätigt.*

*Das Holz wird mit der C14-Datierung in der Universität von "La Sapienza" untersucht und das Alter variiert zwischen 7.000 und 50.000 Jahre.*

## GUIDA ALL'ACQUISTO

Le dimensioni di questi tronchi permettono la realizzazione di tavoli in pezzo unico che vanno dai 2 sino ai 12 m. di lunghezza, il limite delle dimensioni dei tavoli è dettato dai limiti di capienza dei container utilizzati per il trasporto. Ogni acquirente ha la possibilità di scegliere in esclusiva la propria tavola e di deciderne la finitura che può essere naturale o con resina. La selezione delle tavole è disponibile all'interno dell'apposita area riservata dedicata sul sito di Riva 1920.

## PURCHASE GUIDELINES

*The size of these logs allow the production of tops in one piece between 2 and 12 meters of length, and this limit is due to the size of the containers used for transport. Each purchaser has the possibility to choose his slab and its finish, which can be natural or with resin. The selection of the slabs can be made through the specific reserved area on Riva 1920's website.*

## EINKAUFSRICHTLINIEN

*Die Größe der Stämme erlaubt die Herstellung von Tischen mit Platten aus einem Stück mit Längen zwischen 2 und 12 Meter; die maximale mögliche Länge für die Lieferung in Containers. Jeder Kunde hat die Möglichkeit, seine Platte und die Ausführung mit oder ohne Kunstharz auszuwählen. Die Wahl der Platte kann unter Login in unserer Internetseite getroffen werden.*

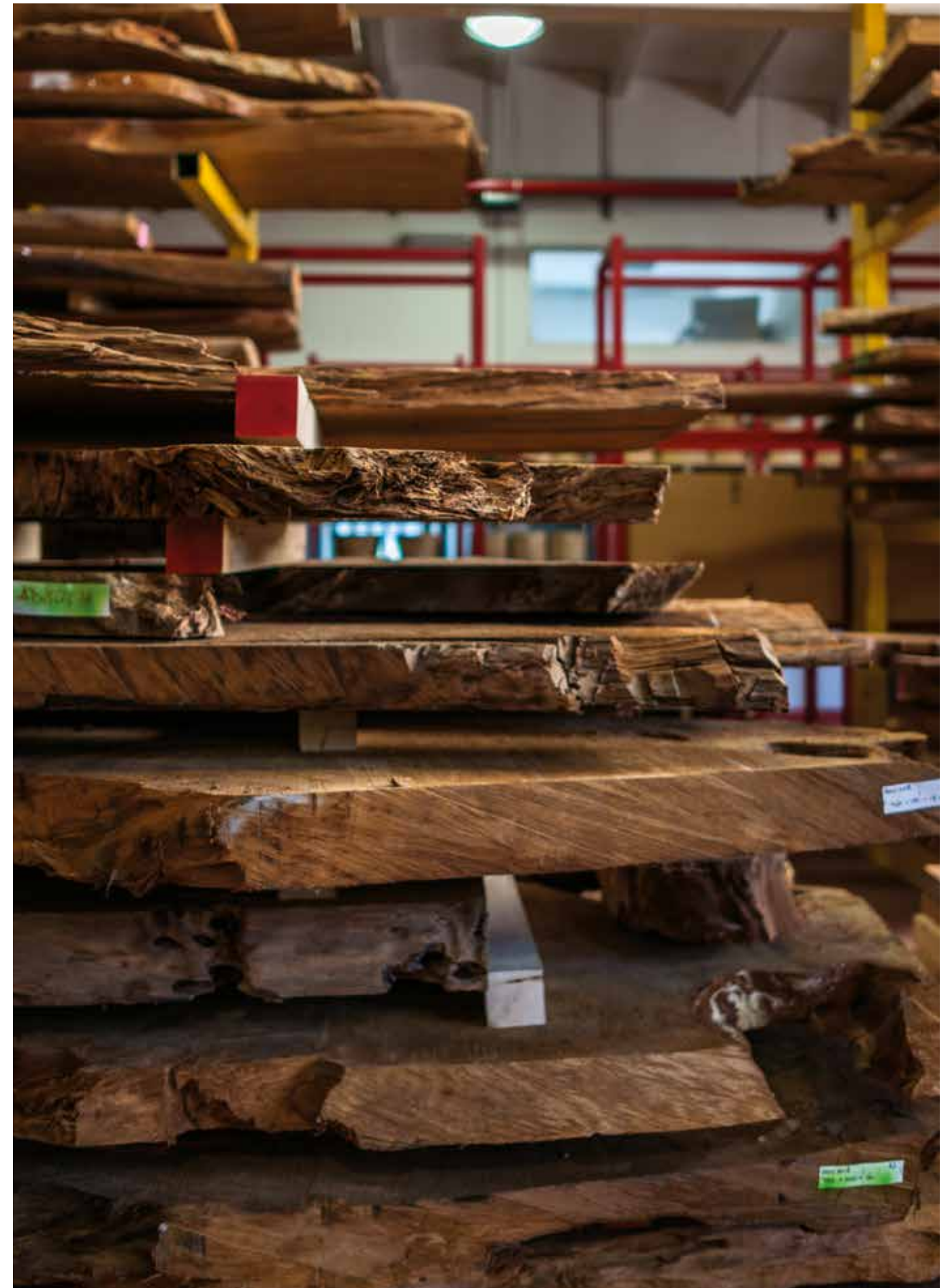



ESSENZE E FINITURE · *WOOD AND FINISHES* · *HÖLZER UND AUSFÜHRUNGEN*

**LEGNO** · WOOD · HOLZ



KAURI LEVIGATO  
MACHINE SANDED KAURI  
KAURI MASCHINELL GESCHLIFFEN



KAURI LEVIGATO CON RESINA  
MACHINE SANDED KAURI WITH RESIN  
KAURI MASCHINELL GESCHLIFFEN MIT HARZ

SONO POSSIBILI LIEVI DIFFERMITÀ CROMATICHE DOVUTE ALLA STAMPA TIPOGRAFICA.  
SLIGHT COLOUR DIFFERENCES MAY BE FOUND ON THE SURFACE AS A CONSEQUENCE OF PRINTING.  
GERINGE FARBABWEICHUNGEN SIND DRUCKBEDINGT MÖGLICH.

## TARGHETTA DI IDENTIFICAZIONE

A garanzia e dell'originalità del prodotto acquistato ogni tavolo è contrassegnato da una targhetta di identificazione che riporta il logo dell'Azienda.

### IDENTIFICATION PLATE

To guarantee the originality of the table purchased, each product is marked with an identification plate showing the Company logo.

### LOGO PLAKETTE

Zur Garantie der Echtheit ist jeder Tisch mit einer Logo Plakette gekennzeichnet.

## MARCHIO A FUOCO

Al fine di rendere unico ogni acquisto, il cliente ha la possibilità di personalizzare il proprio tavolo attraverso un marchio a fuoco in bronzo impresso nel legno in una posizione a scelta.

### IRON STAMP

In order to make each purchase unique, the customer has the possibility to customize his table through an iron stamp to brand the wood in a chosen position.

### BRANDZEICHEN

Auf Anfrage kann jeder Tisch personalisiert werden und ein auf Holz an einer vereinbarten Stelle eingebranntes Markenzeichen erhalten.



## SET MANUTENZIONE

Ogni tavolo è corredato da un kit contenente le istruzioni per la manutenzione ordinaria. Il set di manutenzione è composto da paglietta abrasiva in metallo, guanti in lattice, latte contenenti olii di origine naturale e panno in cotone.

### MAINTENANCE SET

Each table is accompanied by a kit containing instructions for the ordinary maintenance. The maintenance set consists of steel wool, latex gloves, canes of the oil finish and cotton cloth.

### PLEGESET

Mit jedem Tisch wird ein Pflegeset mit Anweisungen für die alltägliche Pflege mitgeliefert. Das Pflegeset enthält eine Stahlwolle, Latexhandschuhen, Dosen des Öls und Baumwolltuch.



## NATURAL LIVING

### LA NOSTRA FILOSOFIA DEL "VIVERE NATURALE"

Ogni cliente che acquista un prodotto Riva 1920, su richiesta può ricevere in omaggio un piccolo alberello, coltivato a partire dal seme in vivai appositamente creati, da piantare nel giardino di casa, in un bosco oppure in un parco. Per chi non sarà in grado di mettere a dimora la piantina, Riva 1920 ha pensato anche "all'adozione a distanza". Per partecipare al progetto Natural Living è sufficiente compilare il modulo scaricabile dal sito internet [www.riva1920.it](http://www.riva1920.it) e presentarlo al momento dell'acquisto presso il punto vendita autorizzato. Con questo semplice gesto il ciclo della natura non si interrompe, prendersi cura dell'ambiente deve diventare uno stile di vita ed un impegno concreto per la salvaguardia delle prossime generazioni.

### OUR PHILOSOPHY OF "LIVING NATURALLY"

Upon request those who buy a product of Riva 1920's collection will receive a gift of a little seed-grown tree cultivated in specially created nurseries, to be planted in a garden, in a wood or in a park. For those who, while supporting the initiative, cannot plant this gift because they do not have a suitable space, Riva 1920 will arrange "long-distance adoption". In order to take part to our Natural Living Initiative, please download the form in our website [www.riva1920.it](http://www.riva1920.it) and take it to the official Riva 1920 authorized retailer when buying a product. With this simple gesture the cycle of nature doesn't stop, taking care of the environment must become a lifestyle and a concrete commitment to preservation for future generations.

### UNSERE PHILOSOPHIE VON „NATÜRLICH LEBEN“

Jeder Kunde, der ein Produkt von Riva 1920 erwirbt, kann auf Anfrage als Geschenk einen kleinen Baum erhalten, der eigens zu diesem Zweck aus einem Samen in einer Baumschule gezüchtet wurde und im eigenen Garten, in einem Wald oder Park gepflanzt werden kann. Wer das Bäumchen nicht pflanzen kann, hat die Möglichkeit, mit Riva 1920 eine „Patenschaft“ zu vereinbaren. Um am Projekt Natural Living teilzunehmen, einfach das Formular von der Internetseite [www.riva1920.it](http://www.riva1920.it) herunterladen und dieses beim Kauf dem autorisierten Händler vorlegen. Durch diese einfache Geste wird der Naturkreislauf nicht unterbrochen. Die Pflege der Natur muss zu einem Lebensstil und einer konkreten Verpflichtung werden, um die nächsten Generationen zu schützen.



L'immagine proposta è puramente indicativa - The image is purely for information - Das Bild ist nicht verbindlich

## DESIGN ECO

Abitare secondo natura - Più attenzione all'ambiente nei materiali e nei modi di produrre per non sprecare le potenzialità che ogni prodotto naturale ha in sé. Nel petto dell'azienda batte un cuore fatto di legno. Riva 1920 ama la natura, ma anche i suoi clienti ed è per questo che offre un prodotto autentico fatto in vero legno naturale nel pieno rispetto dell'ambiente e delle persone che lo abitano. Rivestimenti, colle, vernici, mobili e molti altri elementi e oggetti di uso quotidiano presenti nelle nostre case, sono accomunati dal contenere formaldeide, un gas incolore dai numerosi derivati e dalle mille proprietà: un potente battericida e disinfettante ma anche un fissativo di uso comune, nonché un ottimo conservante. Peccato però che l'esposizione prolungata alla formaldeide, le cui molecole tendono con il tempo ad essere rilasciate nell'ambiente circostante, sia potenzialmente tossica facendone uno dei più diffusi inquinanti di interni; basti pensare che è stata inserita nell'elenco delle sostanze cancerogene per l'uomo. Proprio per questo motivo da oltre 30 anni Riva 1920 si impegna quotidianamente per garantire la naturalità dei suoi prodotti al fine di assicurare la massima qualità dell'aria indoor necessaria per il benessere fisico di tutta la famiglia.

Living according to the nature - More attention to the environment through the use of materials and methods of production to avoid wasting the potential that every natural product has. In the company's chest beats a wooden heart. Riva 1920 loves nature, and so do its customers; that's why it offers an authentic product in real natural wood, respecting the environment and the people who live in it. Upholstery, glues, paints, furniture and many other elements and everyday things in our homes contain formaldehyde, a colourless gas with various derivatives and with numerous features: a strong bactericide and disinfectant, but also a commonly used fixative and a good preservative.

Bad news is, a prolonged exposure to formaldehyde, whose molecules tend with time to be emitted into the surrounding environment, is potentially toxic, making it one of the most common interior pollutants; in fact it has been listed as one of the carcinogenic substances for the human being. That's why since more than 30 years Riva 1920 is daily committed to guarantee a natural product, in order to ensure good indoor air quality for the family well-being.

Naturgemäß leben - Der Umwelt bei Herstellungsweisen und Materialien mehr Aufmerksamkeit schenken, um das Potenzial von jedem natürlichen Produkt nicht zu verschwenden. In der Brust des Unternehmens schlägt ein Herz aus Holz. Riva 1920 und auch seine Kunden lieben die Natur und daher wird ein echtes Produkt aus natürlichem Holz angeboten, das sowie die Natur als auch die Personen achtet. Verkleidungen, Klebstoffe, Lacke, Möbel und viele andere Elemente und Gegenstände des täglichen Gebrauchs unserer Häuser enthalten Formaldehyd, ein farbloses Gas zahlreicher Derivate und mit vielen Eigenschaften: ein wirkungsvolles keimtötendes und desinfizierendes Mittel, aber auch ein allgemein gebräuchliches Fixiermittel sowie ein ausgezeichnetes Konservierungsmittel. Es ist nur schade, dass eine langandauernde Formaldehyd-Exposition potentiell giftig ist, da seine Moleküle wieder in die Umgebung abgegeben werden, wodurch es zu einem der verbreitetsten verunreinigten Stoffe in Innenräumen zählt. Formaldehyd steht nämlich auf der Liste jener Substanzen, die für den Menschen krebserregend sind. Aus diesem Grund bemüht sich Riva 1920 seit über 30 Jahren täglich, die Natürlichkeit seiner Produkte zu garantieren, um die höchste Luftqualität in Innenräumen sicherzustellen, die für das Wohlbefinden der ganzen Familie wichtig ist.



DESIGN ECO 



ADRIANA BUGANZA  
ALBERTO ALCAMISI  
ALBERTO E FRANCESCO MEDA  
ALBERTO GHIRARDELLO  
**ALDO CIBIC**  
ALDO SPINELLI  
ALEKSANDR MUKOMELOV  
ALESSANDRO BONATO  
ALESSANDRO GUIDOLIN  
**ALESSANDRO MENDINI**  
ALESSANDRO PERCALLO  
ALESSIA GALIMBERTI & SERGIO BIZZARRO  
AMEBE DESIGN STUDIO  
ANDREA BORGOGNI  
**ANDREA BRANZI**  
**ANDREA CASTRIGNANO**  
ANDREA GATTI  
ANDREI MONTEANU  
**ANGELA MISSONI**  
**ANTONIO CITTERIO**  
ANTONIO RODRIGUEZ  
ASCANIO ZOCCHI  
**BALDESSARI E BALDESSARI**  
**BARTOLI DESIGN**  
BENNO VINATZER  
BARBI BOTTAZZO  
BOYAN GRIGOROV  
**BRODIE NEILL**  
**CARLO COLOMBO**  
CENGIZ CIVAN  
CLAUDIA BORGIANI  
CLAUDIA GUARDAVACCARO  
**CLAUDIO BELLINI**  
DANIEL GERMANI  
**DAVID CHIPPERFIELD**  
DAVID DOLCINI  
DAVID KNOTT  
DAVIDE OLDANI  
DESIGN D'URBINO & LOMAZZI  
DODO ARSLAN  
EFREM BONACINA E GIOVANNI MORO  
ELEONORA QUADRI  
**ELIO FIORUCCI**  
ENZO MARI  
ERASMO FIGINI  
FABIO BIAVASCHI  
FABIO LO JACONO  
**FABIO NOVEMBRE**  
FABRIZIO ZAPPA  
FORMEJORD BAUMAN  
**FRANCIS KÉRÉ**  
FRANCO E MATTEO ORIGONI  
**GABRIELE E GIULIANO CAPPELLETTI**  
GALIMBERTI E BIZZARRO  
GIAN GIACOMO BORIN  
GIANLUCA MALGERI  
**GIOVANNA AZZARELLO**  
GIOVANNI MICHELUCCI  
GIULIA PULIMENO  
GUALTIERO MARCHESI  
**HELIDON XHIXHA**  
HIKARU MORI  
HSIAO-CHING WANG  
ISABELLE RIGAL  
JAKE PHIPPS  
**JAMIE DURIE**  
JOHN FORD  
**KARIM RASHID**  
KARSTEN SCHMIDT-HOENSDORF  
KAZUYO KOMODA  
KUNIKO MAEDA KAORI SHIINA

LIA BOSCH  
LUCA MARTORANO  
LUCA PEGOLO  
LUCA SCACCHETTI  
LUCIO BOSCARDIN  
**LUISA CASTIGLIONI**  
MALGERI & ORIGONI  
**MARC SADLER**  
MARCO ACERBIS  
MARCO BAXADONNE  
MARCO BOGA  
**MARCO PIVA**  
MARCO ZANUSO JR  
MARIA SAADEH  
**MARIO BELLINI**  
**MARIO BOTTA**  
**MARIO CUCINELLA**  
MASSIMO MALACRIDA  
MATHIAS HOFFMANN  
MATTEO PONTEVIVO  
**MATTEO THUN**  
**MICHELE DE LUCCHI**  
MICHELE TAVANO  
**MONICA ARMANI**  
MOTOMI KAWAKAMI  
**NERI & HU**  
**PAOLA NAVONE**  
PAOLO E JONATHAN NAVA  
**PAOLO PIVA**  
PAOLO SALVADÈ  
PASSON E SAVORGNANI  
PATRICIA FERRO E GABRIELA DUPEYRON  
**PATRICIA URQUIOLA**  
PATRIZIA BOZUFFI  
**PHILIPPE STARCK**  
PIERGIORGIO CAZZANIGA  
**PIERLUIGI CERRI**  
**PIERO LISSONI**  
**PININFARINA**  
REINALDO ESPAÑOL SÁNCHEZ  
**RENZO E MATTEO PIANO**  
**RICCARDO ARBIZZONI**  
ROBERTO GIACOMUCCI  
ROBERTO SEMPRINI  
ROSA PINUCCIO SCIOLA  
RUGGERO GIULIANI  
SAKURA ADACHI  
SETSU & SHINOBU ITO  
SIMONE CAPPELLO  
**SIMONE MICHELI**  
SOLONI, GRANDE, REVESZ  
STEFANO LAROTONDA  
STEPHANE SCHWARZ  
**STEVE LEUNG**  
STUDIO BALUTTO  
STUDIO NESPOLI E NOVARA  
STUDIO RUIZ  
STUDIO ZERO  
TAPIO ANTILLA  
**TERRY DWAN**  
THOMAS HERZOG  
TOM KELLEY  
TOMOKO AZUMI  
VALENTINO MARENCO  
**VALERIO COMETTI**  
VEGNI DESIGN  
VENEZIANO+TEAM  
VICTORIA AZADINHO BOCCONI  
VIOLATO E QUARENGHI  
VITO NESTA



STYLING  
COMMUNICATION  
GRAPHIC DESIGN

**RIVA 1920**

**MARIKA RIVA**

**ALESSIA BERNARDINELLI**

**CINZIA PORRO**

**GLORIA DI STEFANO**

PRINTED IN 2019

**LA GRAFICA · CANTÙ**

PHOTO

**MARCO BELLO**

**STUDIO ELEVEN**

THANKS TO

**Location:**

**VILLA ARGENTA - Figino Serenza, CO**

**PHARMALIFE RESEARCH S.R.L. - Garbagnate Monastero, LC**

**COL RESIDENZA IN ENGADINA - Celerina-Svizzera**

**Decoration:**

**CENTROFORME ARREDAMENTI - Cermenate, CO**

COPYRIGHT © RIVA 1920  
ALL RIGHTS RESERVED.

ANY REPRODUCTION,  
REPRESENTATION  
OR MODIFICATION,  
IN FULL OR PARTLY, OF THIS  
CATALOGUE  
IS EXPRESSLY PROHIBITED.

FOR FURTHER INFORMATION  
PLEASE VISIT [www.riva1920.it](http://www.riva1920.it)

Descriptions, colours and pictures of products included in this catalogue have an indicative value only and are not binding for products use. Riva 1920 reserves the right to modify their products without prior notification.

Riva 1920 è ora disponibile su scala globale in oltre 90 Paesi attraverso una rete di oltre 450 punti vendita autorizzati.

*Riva 1920 is now globally available in more than 90 Countries with an authorized Dealer network of 450 Stores.*

*Riva 1920 ist jetzt weltweit in mehr als 90 Länder vertriebt, und zählt ungefähr 450 offizielle Händler.*



**RIVA 1920**

**Industria Mobili SPA**

Via Milano, 137  
22063 Cantù  
Como · Italy  
T. +39 031 73 30 94  
F. +39 031 73 34 13  
info@riva1920.it

**Production unit - 1**

Via Milano, 137  
22063 Cantù  
Como · Italy

**Production unit - 2**

Via Genova, 13  
22063 Cantù  
Como · Italy

**Production unit - 3**

Via Como, 74  
22066 Mariano C.se  
Como · Italy

**Riva Center**

Via Milano, 110  
22063 Cantù  
Como · Italy

**Riva Farm**

Cucciago  
Como · Italy